

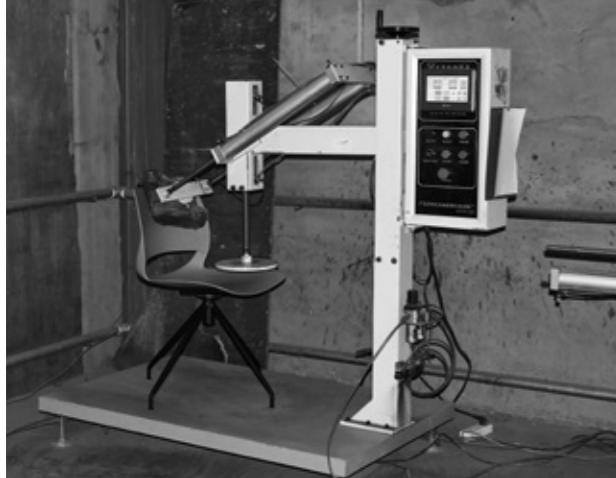

Plastic chairs

坚持做感动人心 价格厚道的好产品

Adhere to the price of good products touched people

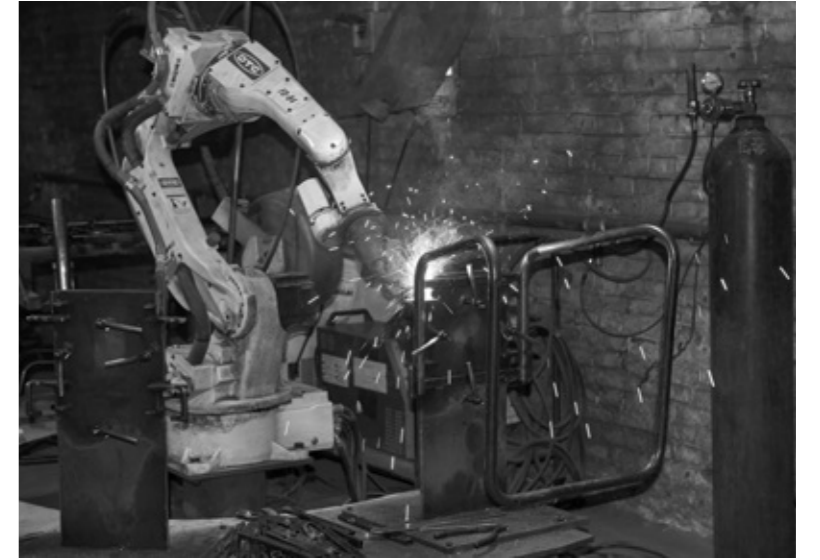

质量检测 + 机器设备

Quality Inspection  
Machinery and  
equipment









## F18D —— 极简百搭设计

MINIMALIST VERSATILE DESIGN

12mm 实芯圆钢 | 德国拜尔 PC 耐磨地脚 | 中国石化工程 PP+15%GF | 加硬加胶防松螺丝 | 可更换设计软包座垫



## Leisure office°

What you give to work is more than what you pay for it.  
Always maintain a perfect working attitude and strive towards the goal  
with hope and enthusiasm.



## F18M —— 极简百搭设计

MINIMALIST VERSATILE DESIGN

14mm 实芯圆钢 | 德国进口烘干榉木 | 中国石化工程 PP+15%GF | 加硬加胶防松螺丝 | 可更换设计软包座垫



## Leisure<sup>o</sup> life experience

Even the same lounge chair, different combinations, can have different spatial effects.



## F18FA —— 极简百搭设计

MINIMALIST VERSATILE DESIGN

25mm 圆 x1.2 圆管 + 哑光静电喷涂 | 德国拜尔 PC 耐磨地脚 | 中国石化工程 PP+15%GF | 加硬加胶防松螺丝 | 可更换设计软包座垫





## Leisure office°

What you give to work is more than what you pay for it.  
Always maintain a perfect working attitude and strive towards the goal  
with hope and enthusiasm.



## F18T —— 极简百搭设计

MINIMALIST VERSATILE DESIGN

铝合金托盘 | 静压旋转功能 | 铝合金四爪 | 中国石化工程 PP+15%GF | 可更换设计软包座垫





a comfortable chair

Select raw materials with international standards, picky designs with aesthetic standards, and label them with the most stringent safety tests

## F17D —— 极简原创设计

MINIMALIST ORIGINAL DESIGN

12mm 实心圆钢 | 德国拜耳 PC 耐磨地脚 | 中国石化工程 PP | 加硬加胶防松螺丝

Dia12mm solid steel

PC resistant feet from Germany BAYER

Engineering PP from Sinopec

Hardened and glued Anti-loose screws





## F16M —— 极简原创设计

MINIMALIST ORIGINAL DESIGN

14mm 实心圆钢 | 德国进口烘干榉木 | 中国石化工程 PP | 加硬加胶防松螺丝

Dia14mm solid steel

German imported drying beech wood

Engineering PP from Sinopec

Hardened and glued Anti-loose screws



SH38

L61



H73.4

W58.1

# lounge chair°

Even the same lounge chair, different combinations, can have different spatial effects.



## F16D —— 极简原创设计

MINIMALIST ORIGINAL DESIGN

12mm 实心圆钢 | 德国拜尔 PC 耐磨地脚 | 中国石化工程 PP | 加硬加胶防松螺丝 | 可更换设计软包座垫

Dia12mm solid steel

PC resistant feet from Germany BAYER

Engineering PP from Sinopec

Hardened and glued Anti-loose screws

Replaceable soft seat cushion

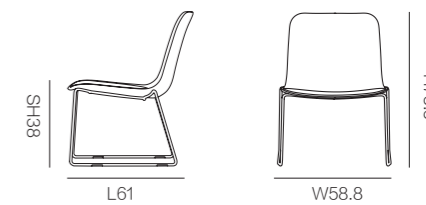

## Leisure office°

What you give to work is more than what you pay for it.  
Always maintain a perfect working attitude and strive towards the goal  
with hope and enthusiasm.



## F12 —— 极简百搭设计

MINIMALIST VERSATILE DESIGN

12mm 实心圆钢 | 中国石化工程 PP | 永不转动脱落 PC 地脚 | 双层镀镍工艺 | 通过 136KG 拉背测试 | 通过 136KG 跌落冲击测试  
Dia12mm solid steel | Engineering PP from Sinopec | Never turn off PC foot | Double-layer nickel plating process | Pass 136KG Pull back tes | Pass 136KG drop impact test

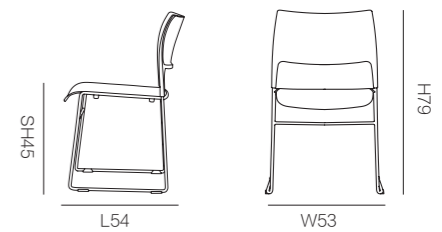

# F12L —— 极简百搭设计

MINIMALIST VERSATILE DESIGN

12mm 实心圆钢 | 中国石化工程 PP | 螺丝固定结构 PC 链接地脚 | 双层镀镍工艺 | 通过 136KG 拉背测试 | 通过 136KG 跌落冲击测试  
Dia12mm solid steel | Engineering PP from Sinopec | Screw fixing structure PC link foot | Double-layer nickel plating process | Pass 136KG Pull back test | Pass 136KG drop impact test

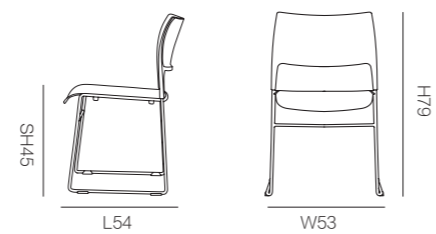

## Leisure<sup>o</sup> life experience

The leisure chair is small, flexible, and varied. It makes full use of the corner space and also has the effect of finishing the finishing touch. Choose a window location, sunbathe during the day and read at night. This will be your relaxing place.



## F11 —— 极简原创设计

MINIMALIST ORIGINAL DESIGN

中国石化工程 PP | 垂直平衡堆叠 | 通过 136KG 拉背测试 | 通过 136KG 跌落冲击测试 | 通过 1000KG 静压测试

Engineering PP from Sinopec

Vertical balance stack

Pass 136KG Pull back test

Pass 136KG drop impact test

Pass 1000KG static pressure test

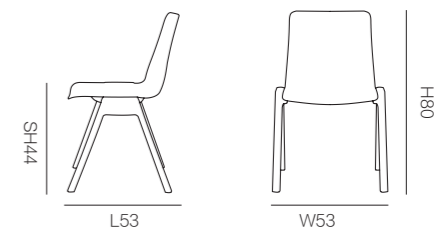

## Leisure office°

What you give to work is more than what you pay for it.  
Always maintain a perfect working attitude and strive towards the goal  
with hope and enthusiasm.



## F11X —— 极简原创设计

MINIMALIST ORIGINAL DESIGN

可加写字板平衡堆叠 | 通过 136KG 拉背测试 | 通过 136KG 跌落冲击测试 | 通过 1000KG 静压测试 | 铝合金支架通过 20KG 静压测试

Balance stack after  
adding tablet

Pass 136KG Pull back test

Pass 136KG drop impact  
test

Pass 1000KG static  
pressure test

Aluminum alloy bracket passed  
20KG static pressure test







## F11L —— 极简原创设计

MINIMALIST ORIGINAL DESIGN

中国石化工程 PP | 垂直平衡堆叠 | 原创链接结构设计 | 通过 136KG 拉背测试 | 通过 136KG 跌落冲击测试 | 通过 1000KG 静压测试  
Engineering PP from Sinopec    Vertical balance stack    Original link structure design    Pass 136KG Pull back test    Pass 136KG drop impact test    Pass 1000KG static pressure test



# F11F —— 极简原创设计

MINIMALIST ORIGINAL DESIGN

中国石化工程 PP | 垂直平衡堆叠 | 通过 136KG 拉背测试 | 通过 136KG 跌落冲击测试 | 通过 1000KG 静压测试

Engineering PP  
from Sinopec

Vertical balance  
stack

Pass 136KG Pull back  
test

Pass 136KG drop impact test

Pass 1000KG static pressure test

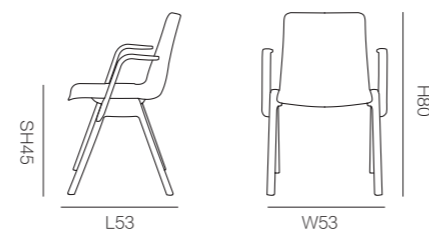
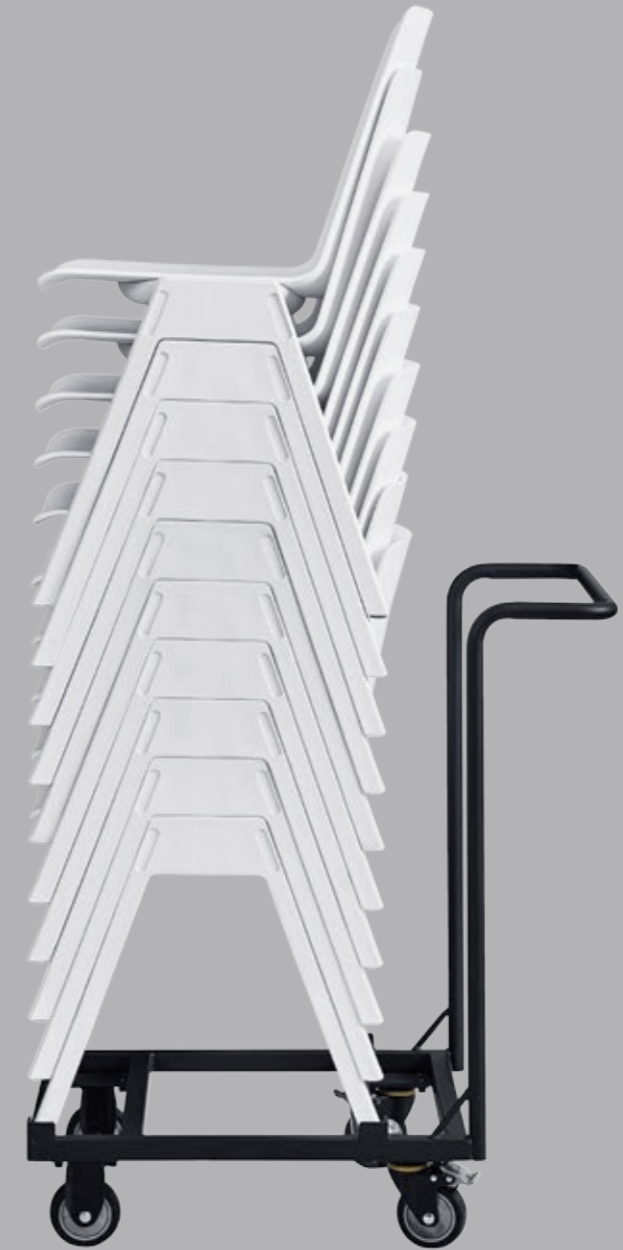

## Fresh style chair

The chair is made of high-quality steel structure, which has a round and full volume while eliminating the heavy volume. The legs made of stainless steel support your weight in a slender but firm manner, and there is no loose feeling during use.



## F10D 简约经典设计

SIMPLE AND CLASSIC DESIGN

12mm 实心圆钢 | 德国拜尔 PC 耐磨地脚 | 中国石化工程 PP | 加硬加胶防松螺丝 | 可更换设计软包座垫

Dia12mm solid steel

PC resistant feet from Germany  
BAYER

Engineering PP from  
Sinopec

The screw with glue and  
Stiffen

Replaceable soft seat  
cushion



## Fresh style chair

The chair is made of high-quality steel structure, which has a round and full volume while eliminating the heavy volume. The legs made of stainless steel support your weight in a slender but firm manner, and there is no loose feeling during use.



## F10FA 简约经典设计

SIMPLE AND CLASSIC DESIGN

中国石化工程 PP | 可更换设计软包座垫 | 立腿管壁 1.5mm | 工程 PP/ 平衡地脚

Engineering PP from Sinopec

Replaceable soft seat cushion

1.5mm thickened pipe wall

Engineering PP / balance feet

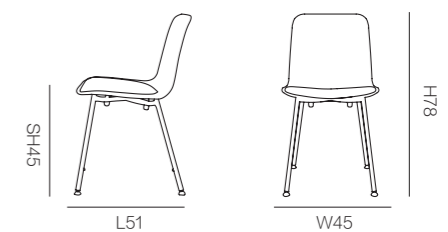

## Leisure<sup>o</sup> life experience

The leisure chair is small, flexible, and varied. It makes full use of the corner space and also has the effect of finishing the finishing touch. Choose a window location, sunbathe during the day and read at night. This will be your relaxing place.



## F10M —— 简约经典设计

ORIGINAL CLASSIC DESIGN

14mm 实心圆钢 | 德国进口烘干榉木 | 中国石化工程 PP | 加硬加胶防松螺丝 | 可更换设计软包座垫

Dia14mm solid steel

German imported drying  
beech wood

Engineering PP from  
Sinopec

the screw with glue and  
Stiffen

Replaceable soft seat cushion

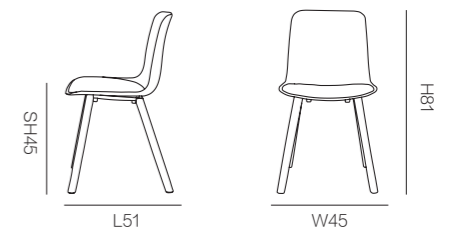



## F10Z —— 极简百搭设计

MINIMALIST, VERSATILE DESIGN

中国石化工程 PP | 铝合金气动托盘 | 2.5mm 炭化处理 4 级气压棒 | 五星脚壁厚 2.0mm; 中心套 5mm | 50 卡簧 PU 静音脚轮  
 Engineering PP from Sinopec | Aluminum Pneumatic tray | 2.5mm carbonized 4-stage gas pressure bar | Five-star foot wall thickness 2.0mm; center sleeve 5mm | 50 reed PU mute castor

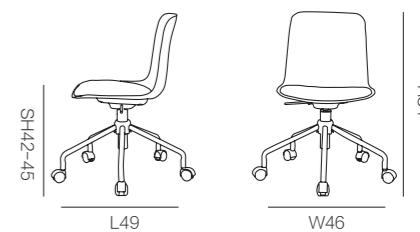

## Leisure<sup>o</sup> life experience

Even the same lounge chair, different combinations, can have different spatial effects.



## F10TZ —— 极简百搭设计

MINIMALIST, VERSATILE DESIGN

中国石化工程 PP | 铝合金托盘 | 2.0mm 管壁; 中心套 5mm | 静压旋转功能 | 可更换设计软包座垫  
Engineering PP from Sinopec | Aluminum alloy tray | 2.0mm pipe wall; center sleeve 5mm | Static pressure rotation function | Replaceable soft seat cushion

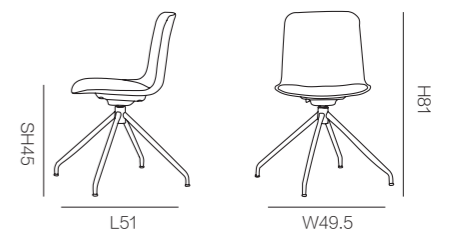



**F10TV** —  
SIMPLE CLASSIC DESIGN

- 尺寸规格  
Size: L51\*W49.5\*H81\*SH45cm
- 产品配置  
极简百搭设计  
中国石化工程 PP  
铝合金托盘  
静压旋转功能  
铝合金木腿固定架  
德国进口烘干榉木  
嵌入式耐磨垫



**F10T** —  
MINIMALIST, VERSATILE DESIGN

- 尺寸规格  
Size: 51\*46.5\*80\*SH45cm
- 产品配置  
极简百搭设计  
中国石化工程 PP  
铝合金托盘  
2.0mm 管壁 +14mm 实心圆钢  
加硬加胶防松螺丝  
可更换设计软包座垫



**F10B** —  
Product description

- 尺寸规格  
Size: 53\*54\*110 SH77cm
- 产品配置  
简约经典设计  
德国拜尔 PC 耐磨地脚  
中国石化工程 PP  
12mm 实心圆钢钢架  
加硬加胶防松螺丝  
可更换设计软包座垫



**F10F** —  
Product description

- 尺寸规格  
Size: 44\*50\*76 SH45cm
- 产品配置  
简约经典设计  
中国石化工程 PP  
可更换设计软包座垫  
管壁厚度 1.5mm  
工程 PP/ 平衡地脚

**F10TV** —

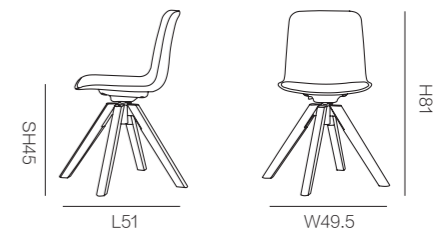

**F10T** —

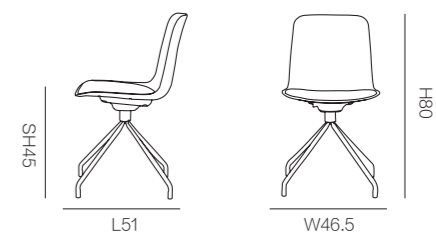

**F10F** —

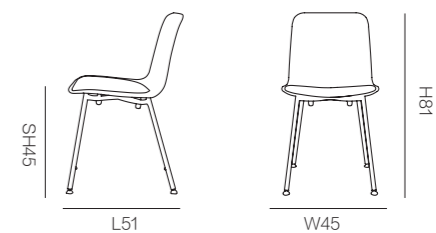

**F10B** —

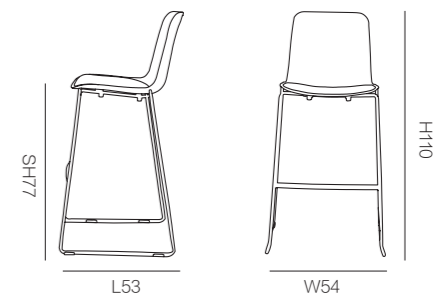





## F9 —— 意大利原创设计

ORIGINAL DESIGN FROM ITALY

超软高回弹海绵 | 极致肤感 PU 皮 | 中国石化工程 PP | 德国进口烘干榉木 | 嵌入式木腿结构 | 嵌入式耐磨垫  
 High-density rebound sponge | Comfortable PU | Engineering PP from Sinopec | Drying beech wood from Germany | Embedded wooden leg structure | Embedded wear-resisting pad



# F9 —— 意大利原创设计

ORIGINAL DESIGN FROM ITALY

超软高回弹海绵 | 极致肤感麻布 | 中国石化工程 PP | 德国进口烘干榉木 | 嵌入式木腿结构 | 嵌入式耐磨垫

High-density rebound sponge

Extreme skin sensitive linen

Engineering PP from Sinopec

Drying beech wood from Germany

Embedded wooden leg structure

Embedded wear-resisting pad

## F9 ——

### Product description

• 产品配置

椅座: 纯新工程 PP +15% 玻纤增强

颜色: 抗 UV 等级防变色色母

座垫: 40 密度高回弹海绵 + 板木框架

面料: 600 克; 防污防水麻布

木脚: 进口榉木; 油漆 2 底 1 面处理

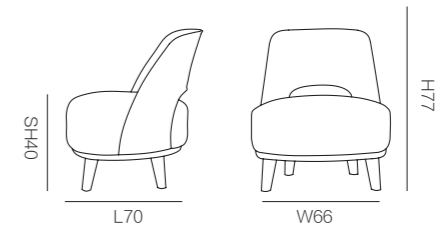



## F8D —— 意大利原创设计

ORIGINAL DESIGN FROM ITALY

12mm 实心圆钢 | 德国拜尔 PC 耐磨地脚 | 中国石化工程 PP | 加硬加胶防松螺丝 | 叠螺防磨软帽  
 Dia12mm solid steel | PC resistant feet from Germany BAYER | Engineering PP from Sinopec | The screw with glue and Stiffe | Soft anti-wear cap for stacking prevents friction

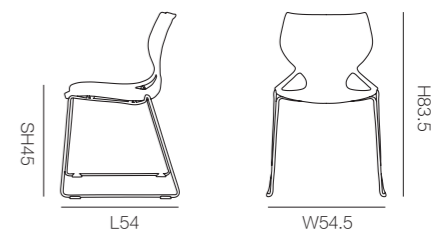

## F8F —— 意大利原创设计

ORIGINAL DESIGN FROM ITALY

立腿管壁 1.8mm | 工程 PP/ 平衡地脚 | 中国石化工程 PP | 加硬加胶防松螺丝 | 叠螺防磨软帽  
 1.8mm vertical leg tube wall | Engineering PP/ Balanced Foot | Engineering PP from Sinopec | The screw with glue and Stiffe | Soft anti-wear cap for stacking prevents friction



## F8T —— 意大利原创设计

ORIGINAL DESIGN FROM ITALY

中国石化工程 PP | 铝合金托盘 | 2.0mm+1.5mm 双层管壁 | 实芯加固地脚  
 Engineering PP from Sinopec | Aluminum alloy tray | 2.0mm+1.5mm double tube wall | Solid reinforcement feet

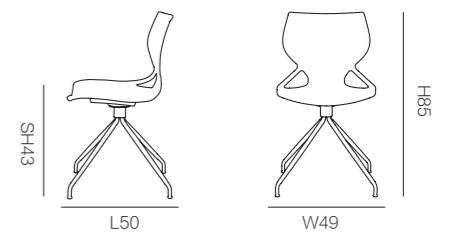

# Wild<sup>o</sup> library

Diversified and varied, making full use of the corner space, but also the finishing touch. Choose a window location, sunbathe during the day and read at night. Here will be your relaxing place.



## F6FA —— 原创经典设计

ORIGINAL DESIGN FROM ITALY

高精度模具制作 | 中国石化工程 PP | 抗 UV 防变色 | 16 圆 1.8mm 厚壁管 | 工程 PP / 平衡地脚  
 High precision tooling produced | Engineering PP from Sinopec | UV resistant color masterbatch. | Dia16MM 18mm thickness tube | Engineering PP / balance feet

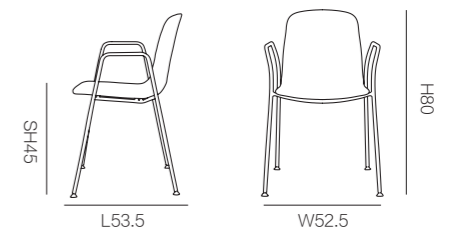

## F6F —— 原创经典设计

ORIGINAL CLASSIC DESIGN

16圆 1.8mm 厚壁管 | 工程 PP/ 平衡地脚 | 中国石化工程 PP | 抗 UV 防变色 | 高精密模具制作  
 16-circle 1.8mm thick-walled tube | Engineering PP/ Balanced Foot | Engineering PP from Sinopec | Anti-UV and Anti-discoloration | Manufacture of High Precision Die



## F6D —— 原创经典设计

ORIGINAL CLASSIC DESIGN

12mm 实心圆钢 | 德国拜尔 PC 耐磨地脚 | 中国石化工程 PP | 抗 UV 防变色 | 高精密模具制作  
 Dia12mm solid steel | PC resistant feet from Germany BAYER | Engineering PP from Sinopec | Anti-UV and Anti-discoloration | Manufacture of High Precision Die





## 8180D —— 意大利原创设计

ORIGINAL DESIGN FROM ITALY

12mm 实心圆钢 | 德国拜尔 PC 耐磨地脚 | 中国石化工程 PP | 加硬加胶防松螺丝 | 座底装饰盖

Dia12mm solid  
round steel

PC resistant feet from  
Germany BAYER

Engineering PP from  
Sinopec

The screw with glue  
and Stiffe

Under seat  
cover

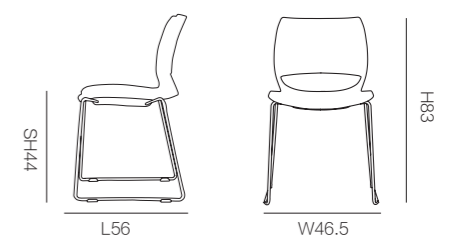



## 8180TZ —— 意大利原创设计

ORIGINAL DESIGN FROM ITALY

中国石化工程 PP | 铝合金托盘 | 2.0mm 管壁; 中心套 5mm | 静压旋转功能 | 可更换设计软包座垫

Dia12mm solid  
round steel

Aluminum  
alloy tray

2.0mm pipe wall; center  
sleeve 5mm

Static pressure  
rotation function

Replaceable soft seat  
cushion

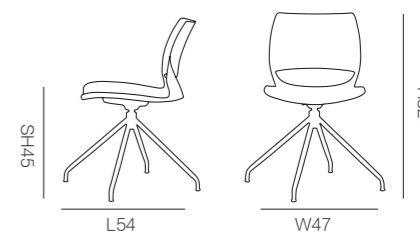



## DELICATE style<sup>o</sup> chair

The chair is made of high-quality steel structure, which has a round and full volume while eliminating the heavy volume. The legs made of stainless steel support your weight in a slender but firm manner, and there is no loose feeling during use.



## 8180T —— 意大利原创设计

ORIGINAL DESIGN FROM ITALY

中国石化工程 PP | 铝合金托盘 | 2.0mm+1.5mm 双层管壁 | 实芯加固地脚

Engineering PP  
from Sinopec

Aluminum  
alloy tray

2.0mm+1.5mm double  
tube wall

Solid reinforcement  
feet

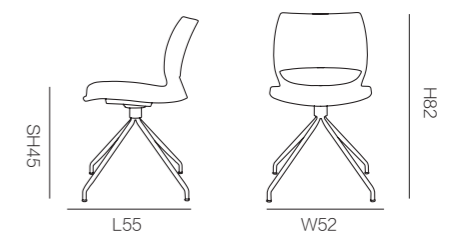



## 8180ZF —— 意大利原创设计

ORIGINAL DESIGN FROM ITALY

中国石化工程 PP | 铝合金气动托盘 | 2.5mm 炭化处理 4 级气压棒 | 五星脚静压通过 1136KG | PU 静音脚轮  
 Engineering PP from Sinopec | Aluminum alloy pneumatic pallet | 2.5mm carbonized 4-stage gas pressure bar | Five-star foot hydrostatic pressure through 1136 KG | PU mute feet wheel

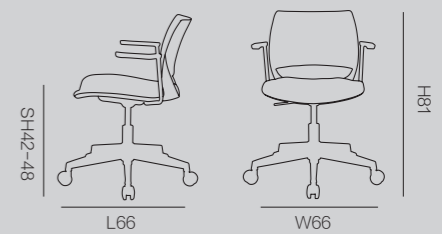

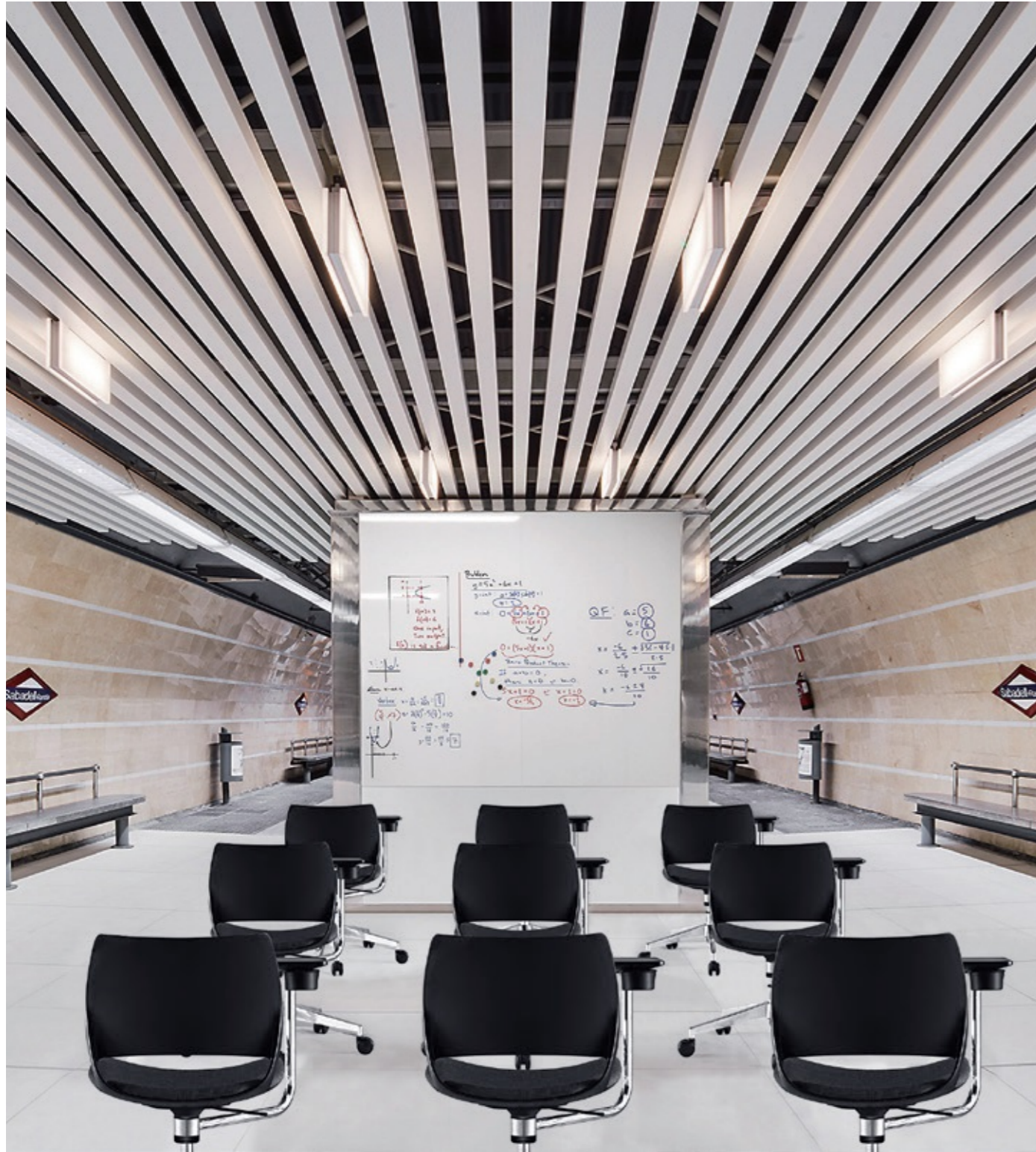

## 8180ZX —— 意大利原创设计

ORIGINAL DESIGN FROM ITALY

铝合金气动托盘 | 写字板承重 -25KG | 支架旋转上拉结构 | 2.5mm 炭化处理 4 级气压棒  
 Aluminum alloy pneumatic pallet | Writing board bearing weight -25KG | Bracket rotation pull-up structure | 2.5mm carbonized 4-stage gas pressure bar

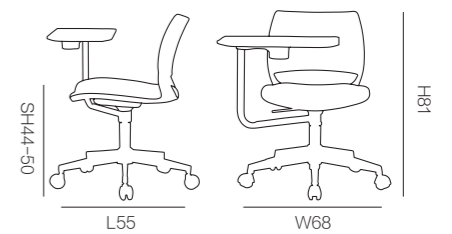

## Office lounge chair

The unique design makes you feel relaxed and relaxed, and the tailor-made design can give you a sense of overall coordination. The relaxed leisure atmosphere is completely in line with your requirements.



## 8180R —— 意大利原创设计

ORIGINAL DESIGN FROM ITALY

中国石化工程 PP | 德国进口烘干榉木 | 木架极致肤感漆面 | 嵌入式耐磨垫  
Engineering PP from Sinopec | German imported drying beech wood | Ultimate skin-sensitive finish Wood leg | Embedded wear-resisting pad

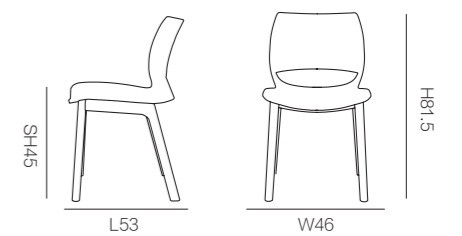

## 8180TV —— 意大利原创设计

ORIGINAL DESIGN FROM ITALY

中国石化工程 PP | 铝合金托盘 | 静压旋转功能 | 铝合金木腿固定架 | 德国进口烘干榉木 | 嵌入式耐磨垫  
Engineering PP from Sinopec | Aluminium alloy tray | Static pressure rotation function | Aluminum alloy wooden leg fixator | German imported drying beech wood | Embedded wear-resisting pad



## 8180F —— 意大利原创设计

ORIGINAL DESIGN FROM ITALY

中国石化工程 PP | 1.8mm 厚壁管 | 加硬加胶防松螺丝 | 工程 PP/平衡地脚 | 座底装饰盖  
Engineering PP from Sinopec | 1.8mm thick-walled tube | Hardening and gluing anti-loosening screw | Engineering PP/Balanced Foot | Pedestal decorative cover



# 8180B —— 意大利原创设计

ORIGINAL DESIGN FROM ITALY

12mm 实心圆钢 | 德国拜尔 PC 耐磨地脚 | 中国石化工程 PP | 加硬加胶防松螺丝 | 座底装饰盖

Dia12mm solid  
round steel

PC resistant feet from  
Germany BAYER

Engineering PP from  
Sinopec

The screw with glue  
and Stiffe

Under seat  
cover



8180F ——

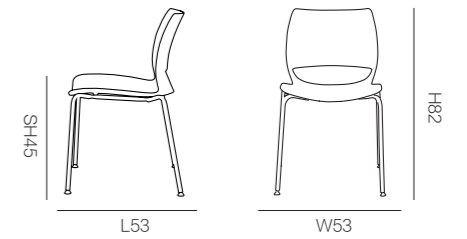

8180TV ——

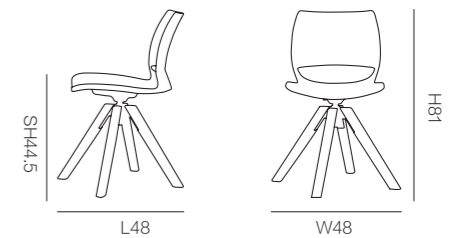

8180B ——

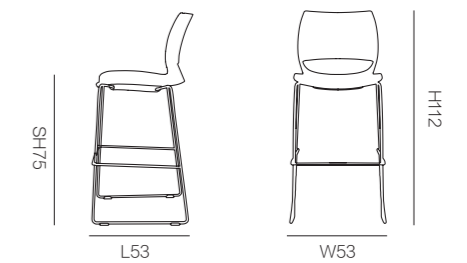

# 8178RB —— 丹麦设计师原创

ORIGINAL DESIGNER FROM DENMARK

座板壁厚 8mm | 严密内胆座垫 | PA 木架连接件 | 多层榉木皮压制成型 | 木腿极致肤感漆面

Thickness 8MM for the shell

Tight liner seat cushion

PA Wooden frame connector

Many layers of beech bark were pressed produce

Ultimate skin-sensitive finish Wood leg



## 8178V ——

### Product description

- 尺寸规格  
Size: L49\*W49\*H80\*SH45cm
- 产品配置  
丹麦设计师原创  
座板壁厚 8mm  
德国进口烘干榉木  
木架通过 SGS; 冲击测试  
木架极致肤感漆面  
嵌入式耐磨垫



## 8178FB ——

### Product description

- 尺寸规格  
Size: L48\*W46\*H78\*SH45.5cm
- 产品配置  
丹麦设计师原创  
座板壁厚 8mm  
严密内胆座垫  
2.0mm+1.5mm 双层管壁  
专用平衡地脚



## 8178YB ——

### Product description

- 尺寸规格  
Size: L48\*W50\*H78\*SH42.5cm
- 产品配置  
丹麦设计师原创  
座板壁厚 8mm  
严密内胆座垫  
12mm 实心圆钢钢架  
德国进口烘干榉木  
木架极致肤感漆面

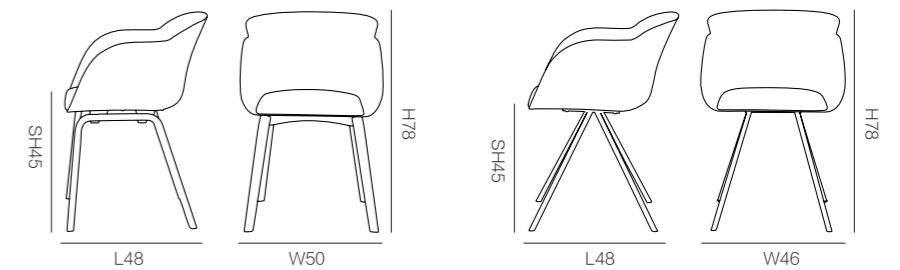

## Leisure Dining chair

When completely new modern materials meet the simple designs of post-modern aesthetics, the natural noble temperament makes all those who love high-tech materials badly clinging to it.



### 8177V — Product description

- 产品配置  
 丹麦设计师原创  
 座板壁厚 8mm  
 德国进口烘干榉木  
 木架通过 SGS；冲击测试  
 木腿极致肤感漆面  
 嵌入式耐磨垫

### 8177RB — Product description

- 产品配置  
 丹麦设计师原创  
 座板壁厚 8mm  
 严密内胆半包座垫  
 极致肤感 PU 皮 / 高密度羊绒布  
 PA 木架连接件  
 多层榉木皮压制成型  
 木腿极致肤感漆面

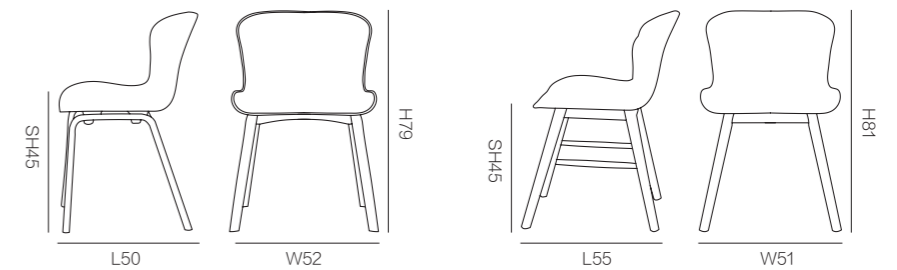



## 8176S —— 原创经典设计

ORIGINAL CLASSIC DESIGN

中国石化工程 PP | 钻石切面纹理 | 人体工学贴背设计 | 椅腿静压 500KG

Engineering PP from Sinopec

Cut diamond texture

Ergonomic back strap design

Static pressure of chair leg is 500KG



## 8176BD —— 原创经典设计

ORIGINAL CLASSIC DESIGN

钻石切面纹理 | 12mm 实心圆钢 | 德国拜尔 PC 耐磨地脚 | 中国石化工程 PP | 加硬加胶防松螺丝

Cut diamond texture

Dia12mm solid round steel

PC resistant feet from Germany BAYER

Engineering PP from Sinopec

Hardened and glued Anti-loose screws





**8176F** ——

**Product description**

- 尺寸规格  
Size: L49\*W47\*H77\*SH44cm
- 产品配置  
原创经典设计  
钻石切面纹理  
管壁厚度 1.5mm  
中国石化工程 PP  
加硬加胶防松螺丝



**8176T** ——

**Product description**

- 尺寸规格  
Size: L46\*W42\*H78\*SH45cm
- 产品配置  
原创经典设计  
钻石切面纹理  
中国石化工程 PP  
铝合金托盘  
2.0mm 厚管壁



**8176D** ——

**Product description**

- 尺寸规格  
Size: L49\*W49\*H77\*45.5cm
- 产品配置  
原创经典设计  
钻石切面纹理  
12mm 实心圆钢  
德国拜尔 PC 耐磨地脚  
中国石化工程 PP  
加硬加胶防松螺丝



**8175FA** ——

**Product description**

- 尺寸规格  
Size: L47\*W43\*H78\*SH45.5cm
- 产品配置  
原创经典设计  
座板壁厚 7mm  
中国石化工程 PP  
立腿管壁 1.2mm  
热转印 / 黑乌光喷涂



**8175S** ——

**Product description**

- 尺寸规格  
Size: L46\*W46\*H78\*SH45cm
- 产品配置  
原创经典设计  
中国石化工程 PP  
座板壁厚 7mm  
人体工学贴背设计  
椅腿静压 500KG



**8176DF** ——

**Product description**

- 尺寸规格  
Size: L48\*W48\*H77\*SH45.5cm
- 产品配置  
原创经典设计  
钻石切面纹理  
12mm 实心圆钢  
德国拜尔 PC 耐磨地脚  
中国石化工程 PP  
橄榄型扶手设计  
加硬加胶防松螺丝



**8175DB** ——

**Product description**

- 尺寸规格  
Size: L48\*W50\*H77\*SH44cm
- 产品配置  
原创经典设计  
座板壁厚 7mm  
12mm 实心圆钢  
德国拜尔 PC 耐磨地脚  
中国石化工程 PP  
加硬加胶防松螺丝



**8175F** ——

**Product description**

- 尺寸规格  
Size: L49\*W47\*H77\*SH44.5cm
- 产品配置  
原创经典设计  
座板壁厚 7mm  
管壁厚度 1.5mm  
中国石化工程 PP  
加硬加胶防松螺丝

## Leisure Dining chair

When completely new modern materials meet the simple designs of post-modern aesthetics, the natural noble temperament makes all those who love high-tech materials badly clinging to it.



## 8170T —— 原创经典设计

ORIGINAL CLASSIC DESIGN

座板壁厚 8mm | 严密内胆座垫 + 高密度羊绒布 | 管壁厚度 1.5mm | 实芯加固地脚  
Thickness 8MM for the shell | Extreme skin sensation PU leather/high density cashmere fabric | Thickness 1.5MM for tube | Solid reinforcement feet

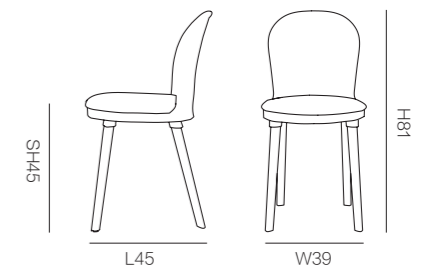

The unique design makes you feel relaxed and relaxed, and the tailor-made design can give you a sense of overall coordination. The relaxed leisure atmosphere is completely in line with your requirements.

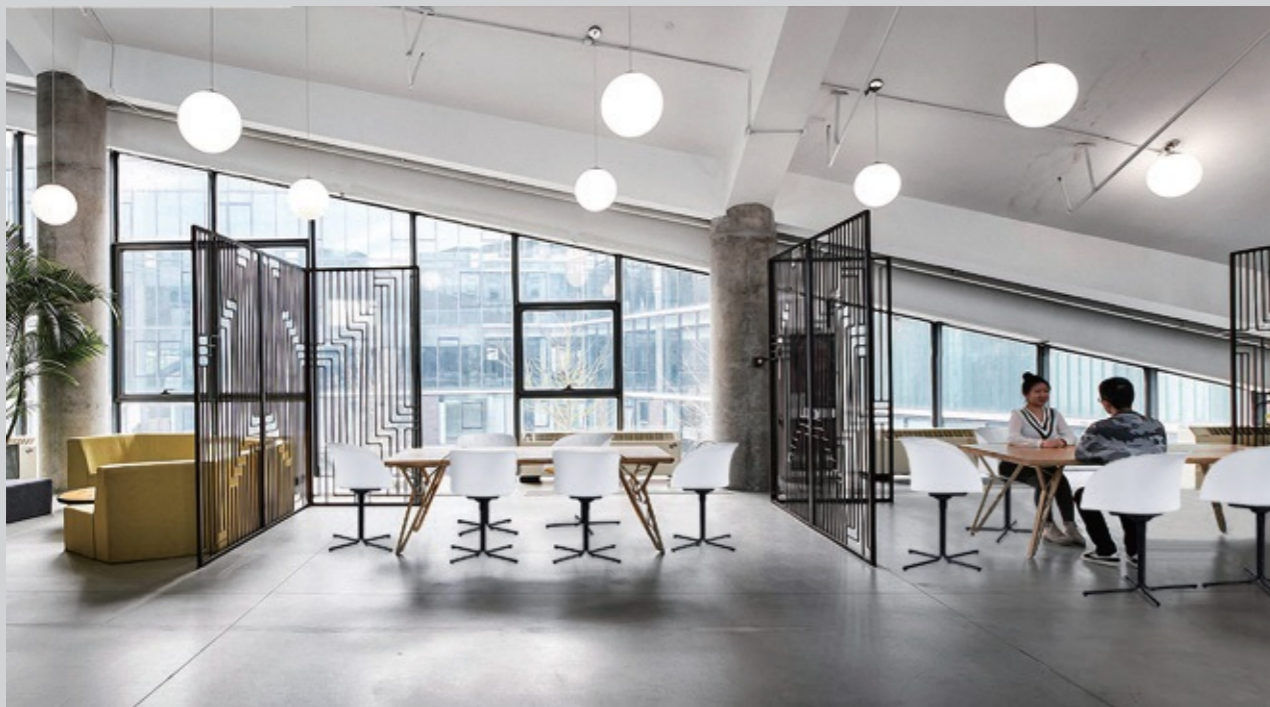

## 8171T —— 原创经典设计

ORIGINAL CLASSIC DESIGN

座板壁厚 7mm | 严密内胆座垫 | 极致肤感 PU 皮 / 高密度羊绒布 | 铝合金托盘 | 2.0mm 厚管壁 +14 圆实芯圆钢

Thickness 7MM for the shell

Tight liner seat cushion

Extreme skin sensation PU leather/high density cashmere fabric

Aluminum alloy tray

2.0mm thick tube wall and Dia14mm solid round steel

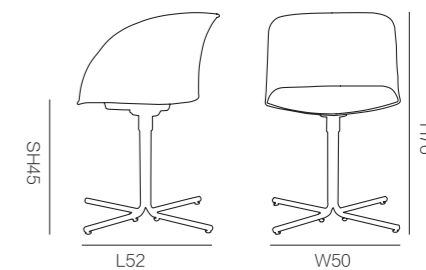



**8105DN** ——

Product description

- 尺寸规格  
Size: L52\*W46\*H80\*SH44cm
- 产品配置  
简约百搭  
中国石化工程 PP  
2.0mm 厚管壁  
防倾仰地脚



**8105F** ——

Product description

- 尺寸规格  
Size: L50\*W53\*H80\*SH44cm
- 产品配置  
中国石化工程 PP  
管壁厚度 1.5mm  
加硬加胶防松螺丝



**8105D** ——

Product description

- 尺寸规格  
Size: L50\*W53\*H80\*SH44cm
- 产品配置  
中国石化工程 PP  
12mm 实心圆钢  
德国拜尔 PC 耐磨地脚  
加硬加胶防松螺丝



**8133S** ——

Product description

- 尺寸规格  
Size: L46\*W46\*H84\*SH46cm
- 产品配置  
中国石化工程 PP  
PU 皮革软包  
塑料椅腿通过静压 500KG



**8133X** ——

Product description

- 尺寸规格  
Size: L52\*W49\*H82\*SH45cm
- 产品配置  
中国石化工程 PP  
加厚加固铁盘  
进口烘干榉木  
PU 皮革软包



**8133C** ——

Product description

- 尺寸规格  
Size: L52\*W49\*H82\*SH45cm
- 产品配置  
中国石化工程 PP  
通过 SGS 测试  
进口烘干榉木  
PU 皮革软包



**8133C** ——

Product description

- 尺寸规格  
Size: L52\*W49\*H82\*SH45cm
- 产品配置  
中国石化工程 PP  
脚蹬管壁 1.2mm  
进口烘干榉木  
PU 皮革软包



**8133C** ——

Product description

- 尺寸规格  
Size: L52\*W49\*H82\*SH45cm
- 产品配置  
中国石化工程 PP  
通过 SGS 测试  
进口烘干榉木  
PU 皮革软包



**8133D** ——

Product description

- 尺寸规格  
Size: L43\*W43\*H81\*SH45cm
- 产品配置  
中国石化工程 PP  
10mm 实心圆钢立腿  
电镀工艺  
PU 皮革软包  
工程 PP/ 平衡地脚



**8168NE** ——  
Product description

- 尺寸规格  
Size: L47\*W47\*H82\*SH45.5cm
- 产品配置  
座板壁厚 8mm  
PA 木腿连接件  
7mm 实心圆钢连接件  
德国进口烘干榉木  
嵌入式耐磨垫  
拆装结构节约体积



**8168D** ——  
Product description

- 尺寸规格  
Size: L48\*W48\*H81\*SH45cm
- 产品配置  
座板壁厚 8mm  
12mm 实心圆钢  
德国拜尔 PC 耐磨地脚  
中国石化工程 PP  
加硬加胶防松螺丝



**8168NEB** ——  
Product description

- 尺寸规格  
Size: L49\*W44\*H103\*SH67cm
- 产品配置  
中国石化工程 PP  
PA 木腿连接件  
7mm 实心圆钢连接件  
德国进口烘干榉木  
嵌入式耐磨垫  
拆装结构节约体积



**8109B** ——  
Product description

- 尺寸规格  
Size: L53\*W50\*H113\*SH78cm
- 产品配置  
中国石化工程 PP  
铝合金螺母镶件  
管壁厚度 1.5mm  
加固地脚



**8109DF** ——  
Product description

- 尺寸规格  
Size: L55.5\*W50\*H109\*SH46cm
- 产品配置  
中国石化工程 PP  
铝合金螺母镶件  
12mm 实心圆钢  
PP 专用扶手  
德国拜尔 PC 耐磨地脚



**8109F** ——  
Product description

- 尺寸规格  
Size: L47\*W47\*H79\*SH45cm
- 产品配置  
中国石化工程 PP  
铝合金螺母镶件  
管壁厚度 1.5mm  
加固地脚



**8169NE** ——  
Product description

- 尺寸规格  
Size: L47\*W47\*H80\*SH45cm
- 产品配置  
中国石化工程 PP  
PA 木腿连接件  
7mm 实心圆钢连接件  
德国进口烘干榉木  
嵌入式耐磨垫  
拆装结构节约体积



**8169S** ——  
Product description

- 尺寸规格  
Size: L46\*W46\*H79\*SH44.5cm
- 产品配置  
中国石化工程 PP  
座板壁厚 7mm  
人体工学贴背设计  
椅腿静压 500KG



**8169D** ——  
Product description

- 尺寸规格  
Size: L43\*W43\*H80\*SH43cm
- 产品配置  
中国石化工程 PP  
12mm 实心圆钢  
德国拜尔 PC 耐磨地脚  
加硬加胶防松螺丝



**8169NEB** ——  
Product description

- 尺寸规格  
Size: L49\*W44\*H103\*SH67cm
- 产品配置  
中国石化工程 PP  
PA 木腿连接件  
7mm 实心圆钢连接件  
德国进口烘干榉木  
嵌入式耐磨垫  
拆装结构节约体积



**8109C** ——  
Product description

- 尺寸规格  
Size: L52\*W49\*H82\*SH45cm
- 产品配置  
中国石化工程 PP  
铝合金螺母镶件  
14mm 实心圆钢  
德国进口烘干榉木  
加硬加胶防松螺丝



**8109DB** ——  
Product description

- 尺寸规格  
Size: L57\*W57\*H78\*SH44cm
- 产品配置  
中国石化工程 PP  
铝合金螺母镶件  
12mm 实心圆钢  
德国拜尔 PC 耐磨地脚  
严密内胆座垫

## Fresh style chair

The chair is made of high-quality steel structure, which has a round and full volume while eliminating the heavy volume. The legs made of stainless steel support your weight in a slender but firm manner, and there is no loose feeling during use.



## F15 —— 极简百搭设计

MINIMALIST VERSATILE DESIGN

抗 UV 防变色 | 高精度模具制作 | 中国石化工程 PP | 气辐保压工艺 | 嵌入式耐磨垫

Anti-UV anti-tarnish

High precision mold making

Engineering PP from Sinopec

Gas radiant pressure maintaining process

Embedded wear-resisting pad

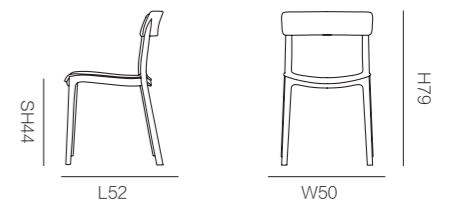

Modern, fashionable, classic and practical.  
It is the pursuit of urban simple furniture.  
Its materials are exquisite, workmanship is  
exquisite, and it strives for perfect design,  
highlights individuality, and becomes the  
tide of furniture development with its keen  
sense of touch.



## 8112 —— 极简百搭设计

MINIMALIST VERSATILE DESIGN

中国石化工程 PP | 抗 UV 防变色 | 高精度模具制作 | 气辐保压工艺 | 嵌入式耐磨垫  
Engineering PP from Sinopec | Anti-UV anti-tarnish | High precision mold making | Gas radiant pressure maintaining process | Embedded wear-resisting pad

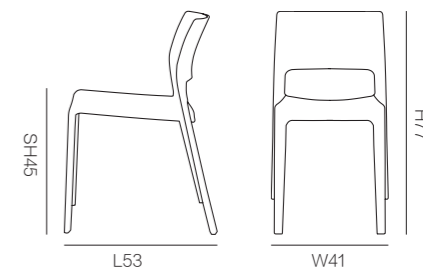



## Leisure Dining chair

When completely new modern materials meet the simple designs of post-modern aesthetics, the natural noble temperament makes all those who love high-tech materials badly clinging to it.



## 8113 — 经典设计

C L A S S I C D E S I G N

中国石化工程 PP | 抗 UV 防变色 | 嵌入式耐磨垫 | 结构稳固

Engineering PP from Sinopec

Anti-UV anti-tarnish

Embedded wear-resisting pad

Stable structure

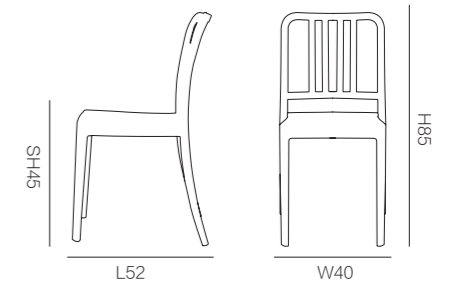



## F13 —— 简约原创设计

SIMPLE ORIGINAL DESIGN

中国石化工程 PP | 抗 UV 防变色 | 高精度模具制作 | 网格结构设计 | 嵌入式耐磨垫

Engineering PP from Sinopec

Anti-UV anti-tarnish

High precision mold making

Grid structure design

embedded wear-resisting pad

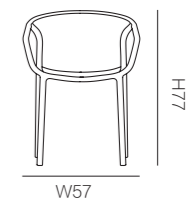
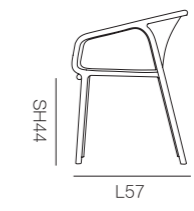

## F7 极简舒适设计

SIMPLE AND COMFORTABLE DESIGN

网格结构设计 | 中国石化工程 PP | 抗 UV 防变色 | 分体拆装结构 | 高精度模具制作 | 嵌入式耐磨垫

Grid structure design

Engineering PP from Sinopec

UV resistant color masterbatch.

Split structure

High precision mold making

Embedded wear-resisting pad



## F7 极简舒适设计

SIMPLE AND COMFORTABLE DESIGN

网格结构设计 | 中国石化工程 PP | 抗 UV 防变色 | 分体拆装结构 | 高精度模具制作 | 嵌入式耐磨垫

Grid structure design

Engineering PP from Sinopec

UV resistant color masterbatch.

Split structure

High precision mold making

Embedded wear-resisting pad





## 8115F —— 经典设计

C L A S S I C D E S I G N

中国石化工程 PP | 抗 UV 防变色 | 嵌入式耐磨垫 | 结构稳固

Engineering PP from Sinopec

Anti-UV anti-tarnish

Embedded wear-resisting pad

Stable structure

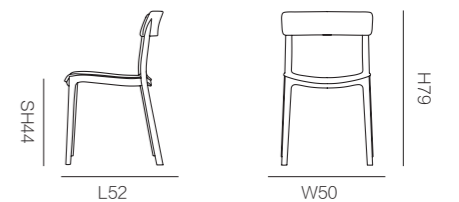



## 8115 — 经典设计

C L A S S I C D E S I G N

中国石化工程 PP | 抗 UV 防变色 | 高精度模具制作 | 网格结构设计 | 嵌入式耐磨垫  
 Engineering PP from Sinopec | Anti-UV anti-tarnish | High precision mold making | Grid structure design | Embedded wear-resisting pad

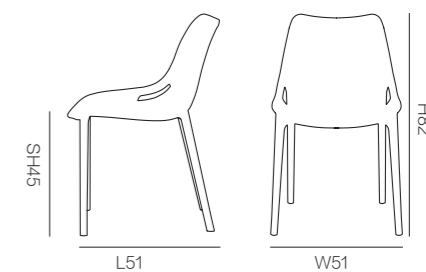



## 8115B —— 简约经典设计

S I M P L E C L A S S I C D E S I G N

- 中国石化工程 PP | 抗 UV 防变色 | 高精度模具制作 | 网格结构设计 | 嵌入式耐磨垫 | 拆卸式脚踏架
- Engineering PP from Sinopec | Anti-UV anti-tarnish | High precision mold making | Grid structure design | Embedded wear-resisting pad | KD structure Foot rest

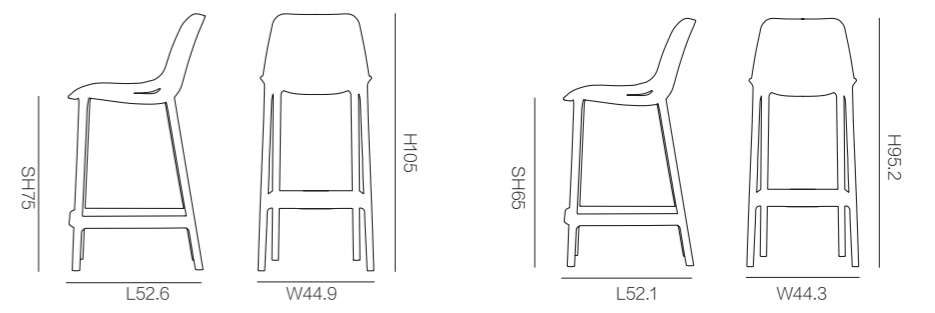



## 8166 — 经典设计

ORIGINAL CLASSIC DESIGN

中国石化工程 PP | 抗 UV 防变色 | 通过 SGS 测试 | 叠螺包装节省体积

Engineering PP from Sinopec

Anti-UV anti-tarnish

Passed SGS test

Stackable packing more save volume

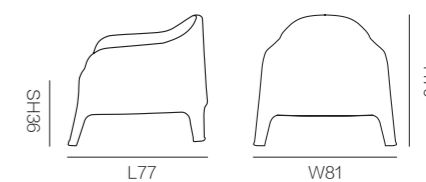



**8111A** —  
Product description

- 尺寸规格  
Size: L61\*W62\*H81\*SH45cm
- 产品配置  
中国石化工程 PP  
铝合金螺母镶件  
通过 SGS 测试  
钢架无痕点焊工艺  
工程 PP/ 平衡地脚  
加硬加胶防松螺丝



**8111Y** —  
Product description

- 尺寸规格  
Size: L73\*W62\*H73\*SH45cm
- 产品配置  
中国石化工程 PP  
铝合金螺母镶件  
通过 SGS 测试  
实心圆钢钢架  
水曲柳木腿



**8111** —  
Product description

- 尺寸规格  
Size: L61\*W62\*H81\*SH45cm
- 产品配置  
中国石化工程 PP  
铝合金螺母镶件  
进口榉木烘干木架  
加硬加胶防松螺丝



**8118F** —  
Product description

- 尺寸规格  
Size: L47\*W47\*H82\*SH45.5cm
- 产品配置  
中国石化工程 PP  
抗 UV 防变色  
嵌入式耐磨垫  
结构稳固



**8118** —  
Product description

- 尺寸规格  
Size: L47\*W47\*H82\*SH45.5cm
- 产品配置  
中国石化工程 PP  
抗 UV 防变色  
嵌入式耐磨垫  
结构稳固



**8116** —  
Product description

- 尺寸规格  
Size: L49\*W44\*H103\*SH67cm
- 产品配置  
中国石化工程 PP  
抗 UV 防变色  
高精密模具制作  
真藤纹理设计  
气辐保压工艺  
嵌入式耐磨垫



**8110A** —  
Product description

- 尺寸规格  
Size: L51\*W47\*H83\*SH46cm
- 产品配置  
中国石化工程 PP  
铝合金螺母镶件  
通过 SGS 测试  
钢架无痕点焊工艺  
工程 PP/ 平衡地脚  
加硬加胶防松螺丝



**8110** —  
Product description

- 尺寸规格  
Size: L40\*W40\*H80\*SH45cm
- 产品配置  
中国石化工程 PP  
铝合金螺母镶件  
通过 SGS 测试  
进口榉木烘干木架  
加硬加胶防松螺丝



**8110B** —  
Product description

- 尺寸规格  
Size: L55\*W55\*H108\*SH71cm
- 产品配置  
中国石化工程 PP  
铝合金螺母镶件  
通过 SGS 测试  
进口榉木烘干木架  
加硬加胶防松螺丝



**8119** —  
Product description

- 尺寸规格  
Size: L47\*W47\*H80\*SH45cm
- 产品配置  
中国石化工程 PP  
抗 UV 防变色  
嵌入式耐磨垫



**8128** —  
Product description

- 尺寸规格  
Size: L49\*W44\*H103\*SH67cm
- 产品配置  
中国石化工程 PP  
抗 UV 防变色  
嵌入式耐磨垫



**8129** —  
Product description

- 尺寸规格  
Size: L46\*W46\*H79\*SH44.5cm
- 产品配置  
中国石化工程 PP  
抗 UV 防变色  
气辐保压工艺  
嵌入式耐磨垫



**8116F** —  
Product description

- 尺寸规格  
Size: L49\*W44\*H103\*SH67cm
- 产品配置  
中国石化工程 PP  
抗 UV 防变色  
高精密模具制作  
真藤纹理设计  
气辐保压工艺  
嵌入式耐磨垫





## T-67 钢板系列 —— 极简经典

THE MINIMALIST CLASSIC

桌面: E1 级雕刻级密度板 | 贴面: 100 克贴面纸光面麻版防油污

钢架: 托盘 x3mm 厚度 + 立杆 75 圆 x1.5mm+ 底盘 6mm 厚



**T-672**  
Size: 70x70x75cm



**T-671**  
Size:  $\phi$  60x75cm



**T-671-1**  
Size:  $\phi$  60x105cm



**T-671-2**  
Size:  $\phi$  60x45cm



**T-675**  
Size:  $\phi$  80x75cm

## T-65 钢板系列 —— 极简经典

THE MINIMALIST CLASSIC

桌面：E1 级雕刻级密度板 | 贴面：100 克贴面纸光面麻版防油污

钢架：底腿 30x70x1.5mm；立柱 60 圆 x1.5mm；上托梁 U 型钢 2mm；链接横梁 20x60x1.5mm

### T-651

Size: 130x70x75cm

### T-651-1

Size: 120x80x75cm

### T-651-2

Size: 130x70x105cm

### T-651-3

Size: 160x70x75cm



## T-62 钢板系列 —— 极简经典

THE MINIMALIST CLASSIC

吉林森工 E0 级 25mm 板材 | 德国夏特 100 克贴面纸 | 极致肤感·油漆封边

Jilin forest industry E0 level 25mm  
thick wooden plate

100g veneer paper from  
German Schattdecor

Extreme skin feeling, paint  
sealing edge

黑色哑光喷涂 | 底座铁板 6mm/ 立柱直径 76mm/ 底托 3mm

Black matte  
coating

Metal plate under the table top thickness 6MM/Dia 76MM  
metal post/bottom metal plate thickness 3MM



**T-629**

Size: 120x80x75cm



**T-627**

Size: 80x80x75cm



**T-625**

Size:  $\phi$  80x75cm



**T-620**

Size:  $\phi$  60x45cm



**T-619**

Size:  $\phi$  60x75cm



**T-621**

Size:  $\phi$  60x100.5cm

## T-61 木腿系列 —— 极简经典

THE MINIMALIST CLASSIC

吉林森工 E0 级 25mm 板材 | 德国夏特 100 克贴面纸 | PA 木腿连接件 | 德国进口烘干榉木 | 木架极致肤感漆面 | 嵌入式耐磨垫

Jilin forest industry E0 level 25mm  
thick wooden plate

100g veneer paper from  
German Schattdecor

PA Wooden frame  
connector

Drying beech wood  
from Germany

Wooden frame extreme  
skin feeling paint

Embedded wear-  
resisting pad



**Y-613**

Size: 120x80x75cm



**Y-615**

Size: 80x80x75cm



**Y-611**

Size:  $\phi$  80x75cm

## TD-635 —— 极简经典

THE MINIMALIST CLASSIC

E1 级 18mm 密度板材 | 底面吸塑工艺 | 底座铁板 2mm/ 底托 2.5mm | 黑色亮光喷涂

E1 level 18mm thick density plate

Bottom suction process

Metal plate under the table top thickness 2MM/bottom metal plate thickness 2.5MM

Black glossy coating



## TD-631 —— 极简经典

THE MINIMALIST CLASSIC

E1 级 18mm 密度板材 | 底面吸塑工艺

E1 level 18mm thick density plate

Bottom suction process

底座铁板 5.5mm/ 立柱直径 60mm/ 底托 2.5mm | 雪白亮光喷涂

Metal plate under the table top thickness 5.5MM/Dia 60MM metal post/bottom metal plate thickness 2.5MM

Snow White glossy coating



# REGULAR COLOR



