



**Dechang**

**杭州德昌五金家具有限公司**  
**Dechang Furniture and Hardware Co.,Ltd**

内销:

地址: 中国, 杭州西湖科技经济园西园八路8号

ADD: NO.8 Xiyuan8Road, West Lake & TrchnoLogy Park, sandun, Hangzhou China.

浙江省内 TEL: +86 571 81958309

浙江省外 TEL: +86 571 81958300

Export:

地址: 中国, 杭州西湖科技经济园西园路6号

ADD: NO.6 XiyuanRoad, West Lake & TrchnoLogy Park, sandun, Hangzhou China.

TEL: +86 571 81958316

Http://www.hzdcwj.com

阿里巴巴:https://www.hzdcwj.1688.com



*Dechang Folding Desks make people do their  
liest wherever they work, learn and live.*

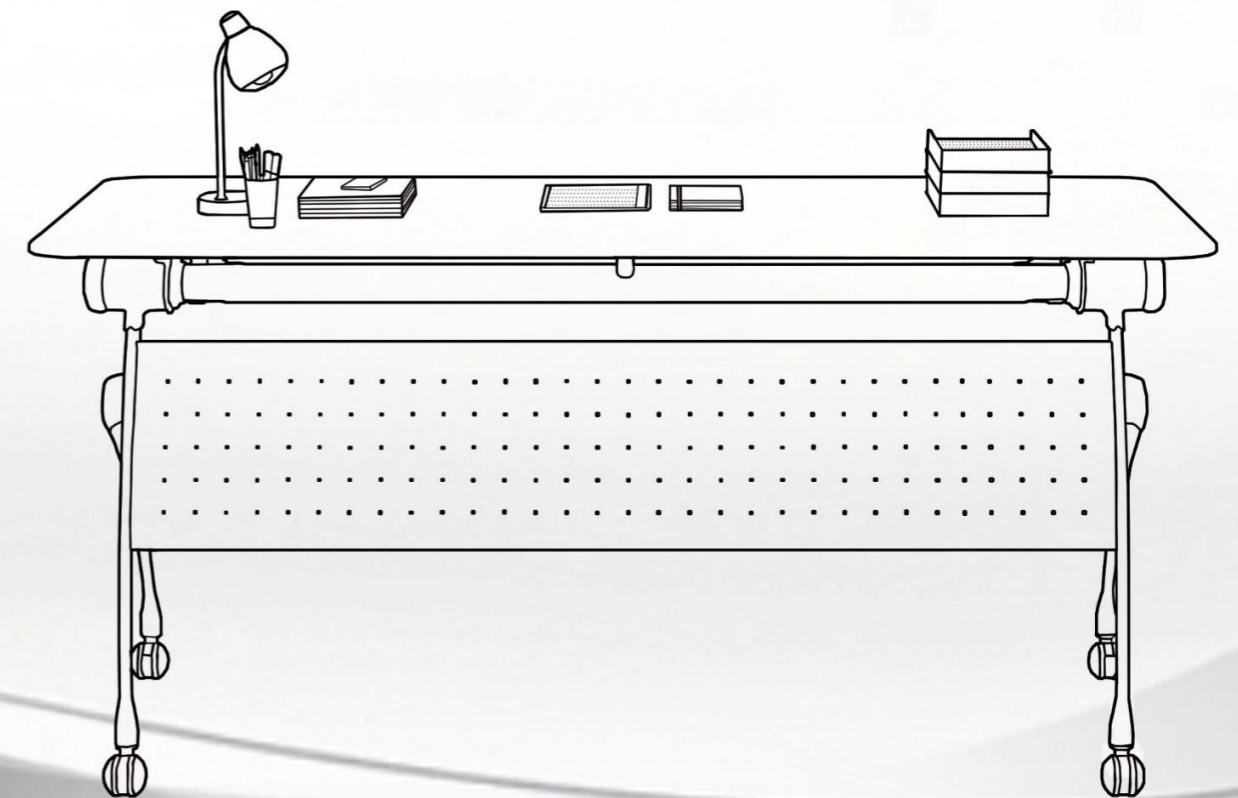

## 公司简介

杭州德昌五金家具有限公司创始于1997年，占地面积60000多平方米，一家集研发、设计、生产、销售为一体的专业化金属家具及配件制造商，致力于为客户提供高品质、健康环保的智能办公家具。

公司先后引进全自动高科技生产设备，建有完善的生产管理体系，经过20年的探索、改进，产品已远销中东、非洲、北美、南美、欧洲、澳洲、东南亚、俄罗斯等200多个国家和地区，积累客户达千余家，广受国内外客商青睐，是全国数一数二的五金家具出口单位，在五金家具行业拥有举足轻重的地位。

我们将秉承“德以诚信，昌以超越”的公司理念，恪守“质量第一、服务周到、客户至上”的原则，打造值得信赖的绿色环保、品质保证的放心家具。真诚期待与您的合作，携手并进，共赴美好未来。

Dechang furniture and hardware co., LTD., founded in 1997, covers an area of more than 60,000 square meters. It is a professional metal furniture and accessories manufacturer integrating research and development, design, production and sales.

The company has introduced automatic high-tech production equipment, has a perfect production management system, after 20 years of exploration and improvement, products have been exported to the Middle East, Africa, North America, South America, Europe, Australia, southeast Asia, more than 200 countries and regions such as Russia, accumulate more than thousands of clients, broadly popular with the domestic and foreign merchants, is one of the biggest hardware furniture exports in the unit, in hardware furniture industry has a pivotal position.

We will adhere to the company philosophy of "our credit gives our confidence for keeping beyond", abide by the principle of "quality first, thoughtful service, customer first", to create reliable green environmental protection, quality assurance assured furniture. We sincerely look forward to cooperating with you hand in hand for a better future.

德以诚信、昌以超越  
Our credit gives  
Our confidence for keeping beyond

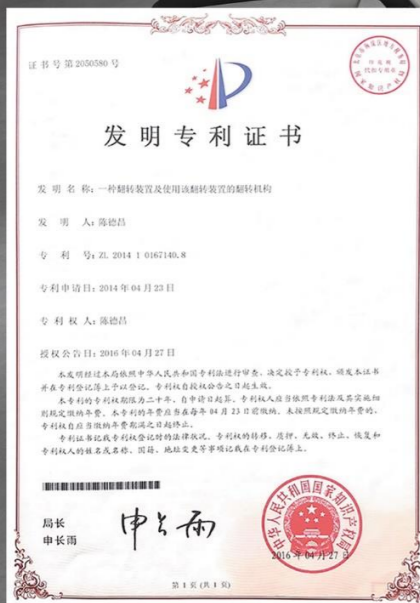



ZF-08C

ZF-08C



Steel specification: 1420 \* 540 \* 715 mm

Top: Elizabeth

Colour:

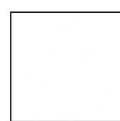

白色/White

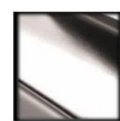

抛光/Buffing



黑无光/Matt Black





ZF-08C

ZF-08C



Steel specification: 650 \* 540 \* 715 mm

Top: Elizabeth

Colour:



白色/White

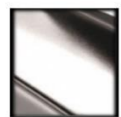

抛光/Buffering



黑无光/Matt Black





ZF-08D



ZF-08D

Steel specification: 1430 \* 520 \* 725mm

Top: Elizabeth

Colour:



白色/White

闪银/Silvery pearl







ZF-08D

# Harmony

A folding table, export quality, exported to both inside and outside. Free splicing, changeable combination, multi-occasion application. Rotation folding storage, humanized design.

一款满足折叠组合的条形桌，出口品质，远销内外。自由拼接，多变组合，多场合应用。旋转折叠收纳，人性化设计。

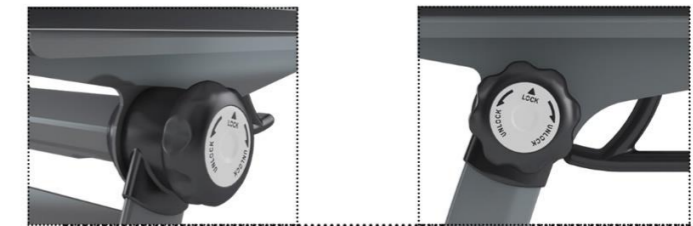

Steel specification: 680 \* 520 \* 725 mm

Top: Elizabeth

Colour:

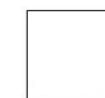

白色/White 闪银/Silvery pearl





ZF-08

# ZF-08

这款桌子轻松、快速地组合搭配。高度的灵活性和机动性，使它非常适合培训、教学中的互动和成员之间的合作、交流，有利于团队活动的开展。

This table is easy and quick to put together. High flexibility and mobility, make it very suitable for training, teaching interaction and between members of the cooperation, communication, conducive to the development of team activities.



# ZF-08



矩形组合台面可以由一个和另一个桌面实施简单的链接动作得以实现，并且可以通过卡扣连接器的装置设置形成您所需要的会议布置形状。

rectangular combined table can be made by a simple desktop continuous action link can be realized, and can be set to form a buckle device connector arranged the meeting you need.

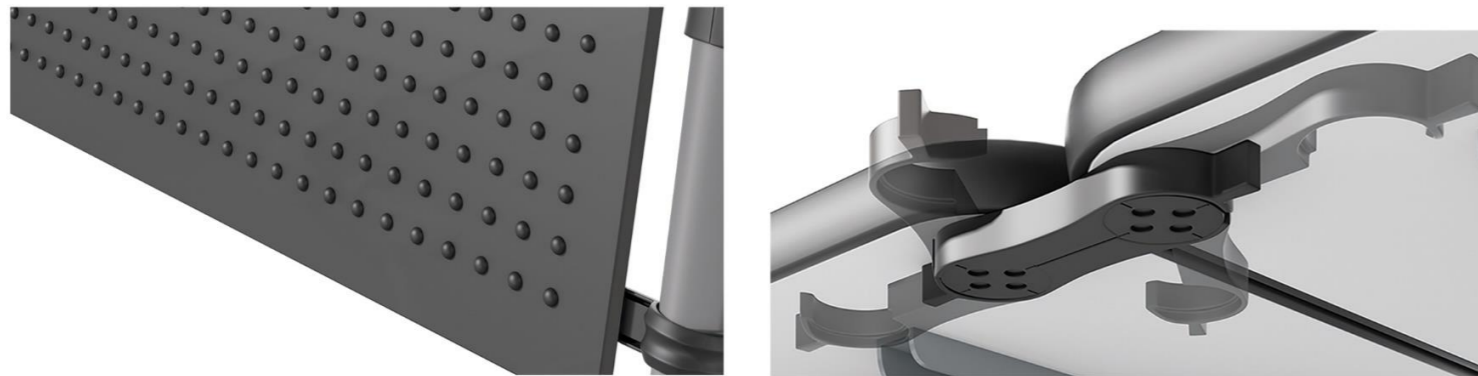

桌面连接系统  
Desktop Connection system.

Steel specification:

1440 \* 540 \* 725 mm

Top: Elizabeth

Colour:



白色/White



闪银/Silvery pearl



# ZF-08



COMPANY  
PROFILES

---



Steel specification: 690\*540\*725mm

Top: Elizabeth

Colour:



白色/White



闪银/Silvery pearl

# PRODUCT INTRODUCTION

A warmer welcome.

多变形态，满足会议环境所需

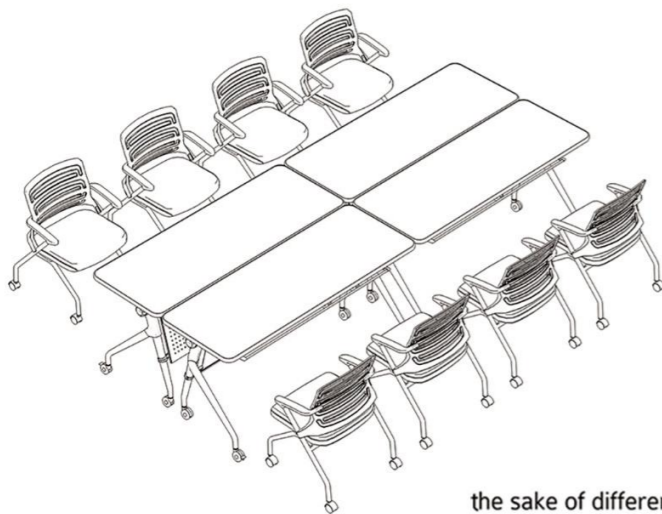
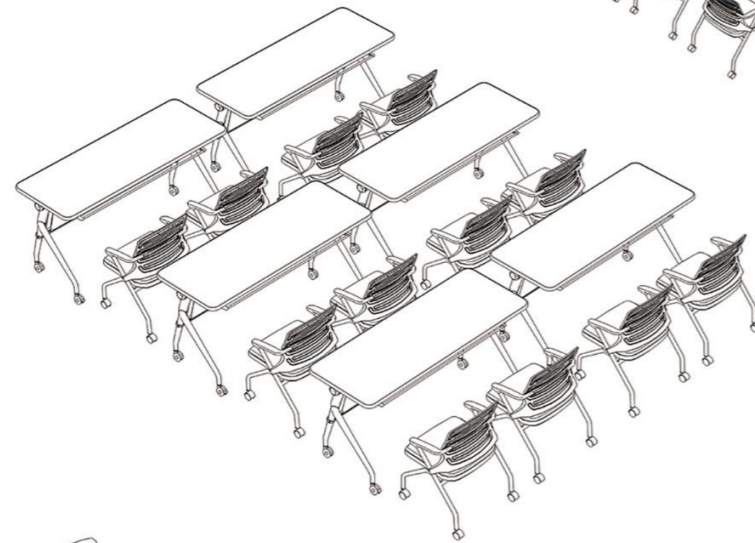
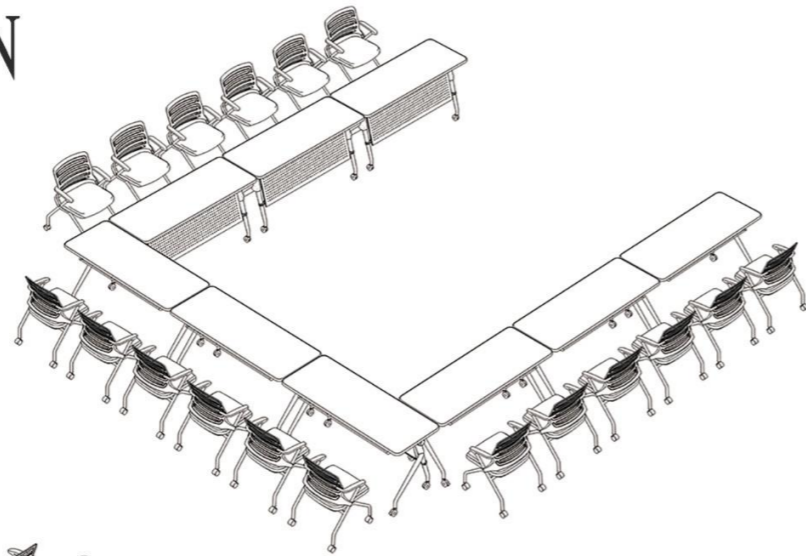

## — 环形会议桌

适用于交流、研讨，面对面观点的碰撞，无论坐在哪个位置，都不妨碍自由发表意见。

## U 型会议桌

提高与会者参与会议的积极性、为服务人员留下便捷通道，配合投影使用，使观点更加清楚明了。

## 培训式会议桌

桌椅摆放整齐、如学校的课桌座位形式，便于记录，满足不同的大型会议需求。

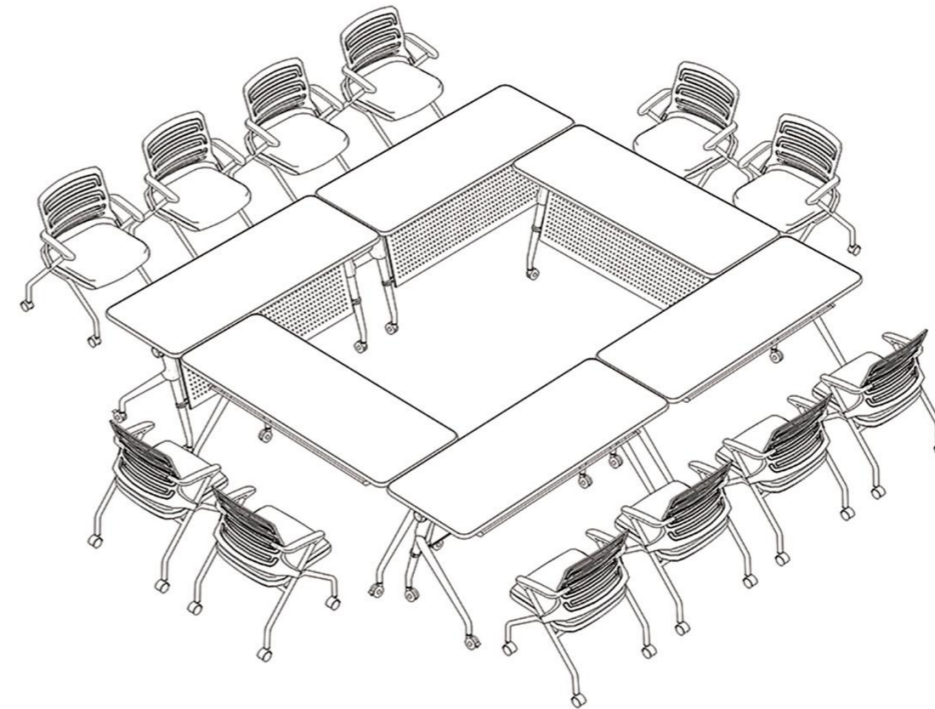

### Circular tables

They are suitable for communication, discussion, face-to-face argument in that you can have a free talk at anywhere.

### U-shaped tables

Stimulate the enthusiasm of participants and provide quick patches for assistants with the help of projection so as to make points more clear

### Tables for training

Chairs and tables placed in a good order like students' desks for the sake of different conferences so that participants can concentrate and make records well by using data conveniently.

Instead of comment on meetings, efficiency and immediate execution after meeting will be the focus of everyone; different meetings demand different layout, forms and Equipment, thus how to realize all demands in the limited space are the focus

不管如何去评论会议，提高会议的效率、会后迅速执行才是大家真正关心的焦点；所以，不同的会议需要不同的环境空间、会议形式、会议设备，而在有限的空间里，又该如何实现这些不同的需要、满足大家关心的焦点问题呢？德昌五金多功能系统会议桌，带你体验会议办公环境中的“变形金刚”。

# ZF-08



安全锁，固定和稳定折叠桌。



Safety lock, fixed and stable folding table.



白色/White



闪银/Silvery pearl

# ZF-08A

—  
我们的培训桌系列，拥有国内外多项专利。巧妙的旋转折叠设计，单手操作无压力，简单折叠，简易收纳。

Training table, has a number of domestic and foreign patents. Clever rotary folding design, one-handed operation without pressure, simple folding, easy storage.



# ZF-08A



ZF-08A系列采用德昌自主知识产权的折叠桌，外形美观，结构稳定，使用方便，可轻松折叠、归类，让有限的空间得以最大化的使用。

ZF-08 Aseries adopts the folding table of Dechang independent intellectual property rights. It has beautiful appearance, stable structure and convenient use. It can be easily folded and categorized so as to maximize the use of limited space.



Steel specification:  
1450\*590\*725mm  
Top: Elizabeth  
Colour:



白色/White 抛光/Buffering 黑无光/Matt Black





ZF-08A



ZF-08A



简约生动的轮廓，贴切人体曲线，给你舒适的感觉，让你的创作灵感源源不断。

Simple and vivid contours, close to the body curve, give you a comfortable feeling, let your creative inspiration.



Steel specification: 1450 \* 590 \* 725 mm

Top: Elizabeth

Colour:



白色/White

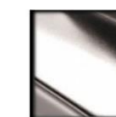

抛光/Buffering



黑无光/Matt Black





ZF-08B

# ZF-08B



Steel specification: 1470 \* 475 \*725 mm

Top: Elizabeth

Colour:



白色/White



闪银/Silvery pearl



简洁、灵动、时尚、青春。这正是成长型企业的特征。这样打会议空间也正是您的期望,三五同事座论伟业,梦想就在这里放飞。

Concise lively fashion,youth.four features of growing compay.This meeting space is the one that you are looking for.A couple of colleague seat and talk about the bright future,this is the place that dream come true



桌面连接系统  
Desktop Connection system.



## ZF-08B

—  
创新桌脚设计，更加柔美，为你提供时尚、稳固的支撑。造型百变，随需应变，会议/培训/教学，一桌多用。

This training table has innovative feet, more soft, and provides you with fashionable and stable support. Variable shape, on demand, meeting/training/teaching, one desk multi-purpose.



ZF-08B



Steel specification:720\*475\*725mm

Top:Elizabeth

Colour:

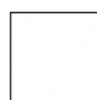

白色/White



闪银/Silvery pearl



## PRODUCT INTRODUCTION



# ZF-10

We believe the only way to provide the best office furniture solutions is to ensure they're the best products for the environment. That's why every step of the way-through design, manufacturing, delivery and product lifecycle-we consider the impact of our work on people and on the environment and uncover opportunities to make things better.



# ZF-10



Steel specification: 1460\*500~680\*725mm

Top: Elizabeth

Colour:



白色/White

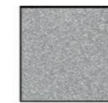

闪银/Silvery pearl

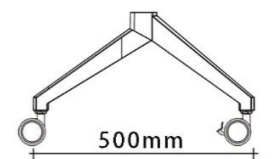
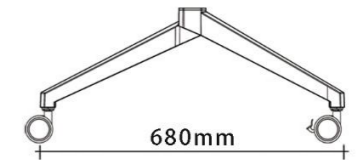





## DEVELOPMENT AND PRODUCTION

-  
We only do what we do best-  
electric control solution for high desk Market Development and production.

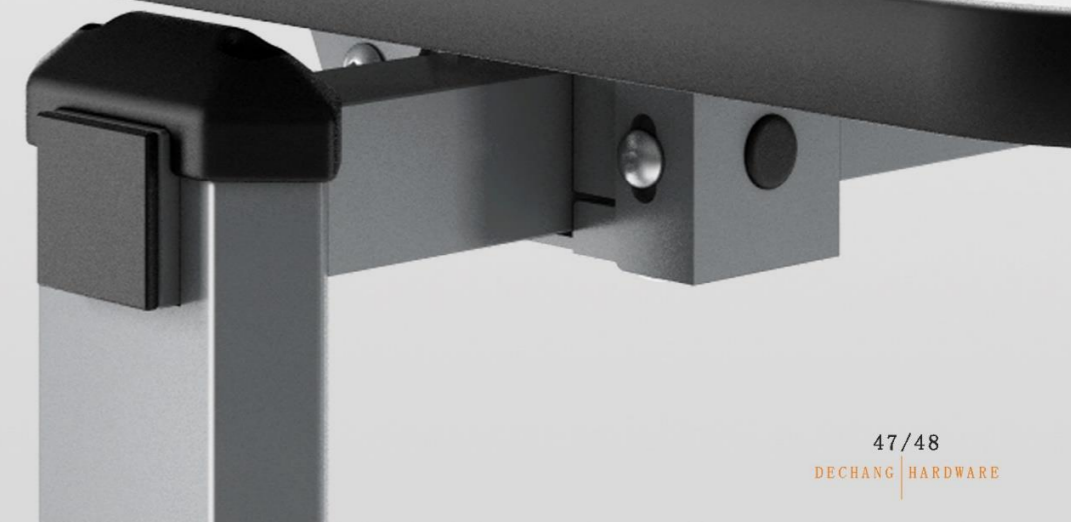

# DF-78FB-01



Colour:



闪银/Silvery pearl 黑无光/Matt Black



# DF-78FB-02



Steel specification:  
1540\*600~750\*725mm  
Top:Elizabeth

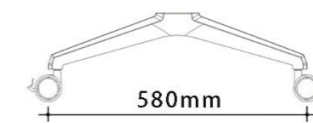
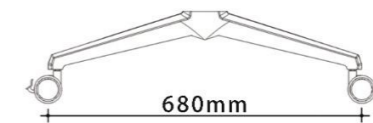



DF-188FB-02

# DF-188FB-02



Steel specification:  
1540\*600~750\*725mm

Top:Elizabeth

Colour:



白色/White 抛光/Buffing

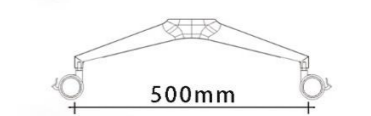
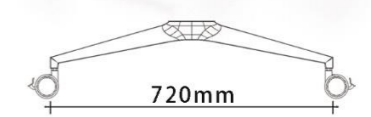



CONCISE AND  
ELEGANT



# DF-188FB-01



Steel specification:  
1540\*600~750\*725mm  
Top:Elizabeth  
Colour:



白色/White

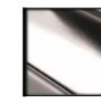

抛光/Buffing





DF-213



DF-213



Steel specification:1495\*620\*725mm

Top:Elizabeth

Colour:

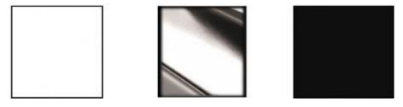

白色/White 抛光/Buffing 黑无光/Matt Black





# DF-213



简约生动的轮廓，贴切人体曲线，给你舒适的感觉，让你的创作灵感源源不断。

Simple and vivid contours, close to the body curve, give you a comfortable feeling, let your creative inspiration.





DF-213



Steel specification:1495\*1430\*725mm

Top:Elizabeth

Colour:



白色/White 抛光/Buffering 黑无光/Matt Black

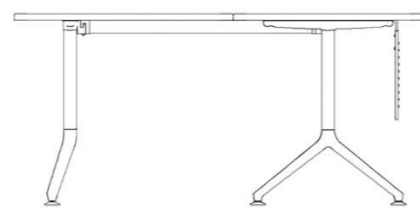

# DF-45XFB-01



Colour:



白色/White



抛光/Buffing

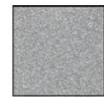

闪银/Silvery pearl



## CONCISE AND ELEGANT



Steel specification:  
1540\*580\*725 mm  
Top:Elizabeth



ZF-15

# ZF-15



Steel specification:1390\*600\*725mm

Top:Elizabeth

Colour:



白色/White 闪银/Silvery pearl 黑无光/Matt Black

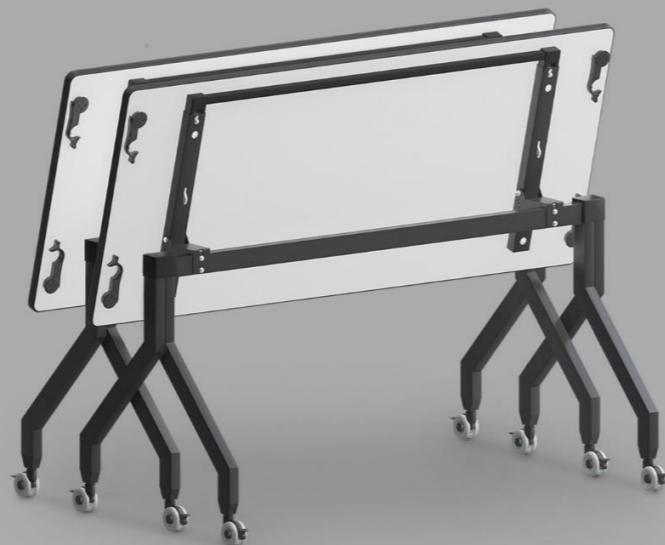

## PRODUCT INTRODUCTION



ZF-16



Steel specification:1400\*500\*725mm

Top:Elizabeth

Colour:



白色/White

闪银/Silvery pearl

黑无光/Matt Black



PRODUCT  
INTRODUCTION



# THE HEIGHT OF FASHION.

They can adjust the desktop to any height, standing calmly sit transition, and then come back. Just adjust the settings to meet for working conditions, and then adjustment lever lifting table. it can be used anywhere.



## ZF-05-01

Steel specification: 1060 \* 440 \* 725 mm



# THE HEIGHT OF FASHION.

---



**ZF-05**

Steel specification: 1060 \* 440 \* 725 mm

—  
They can adjust the desktop to any height,  
standing calmly sit transition,  
and then come back.  
Just adjust the settings to meet for working conditions,  
and then adjustment lever lifting table.  
it can be used anywhere.



Colour:



闪银/Silvery pearl



# Handy

Handy

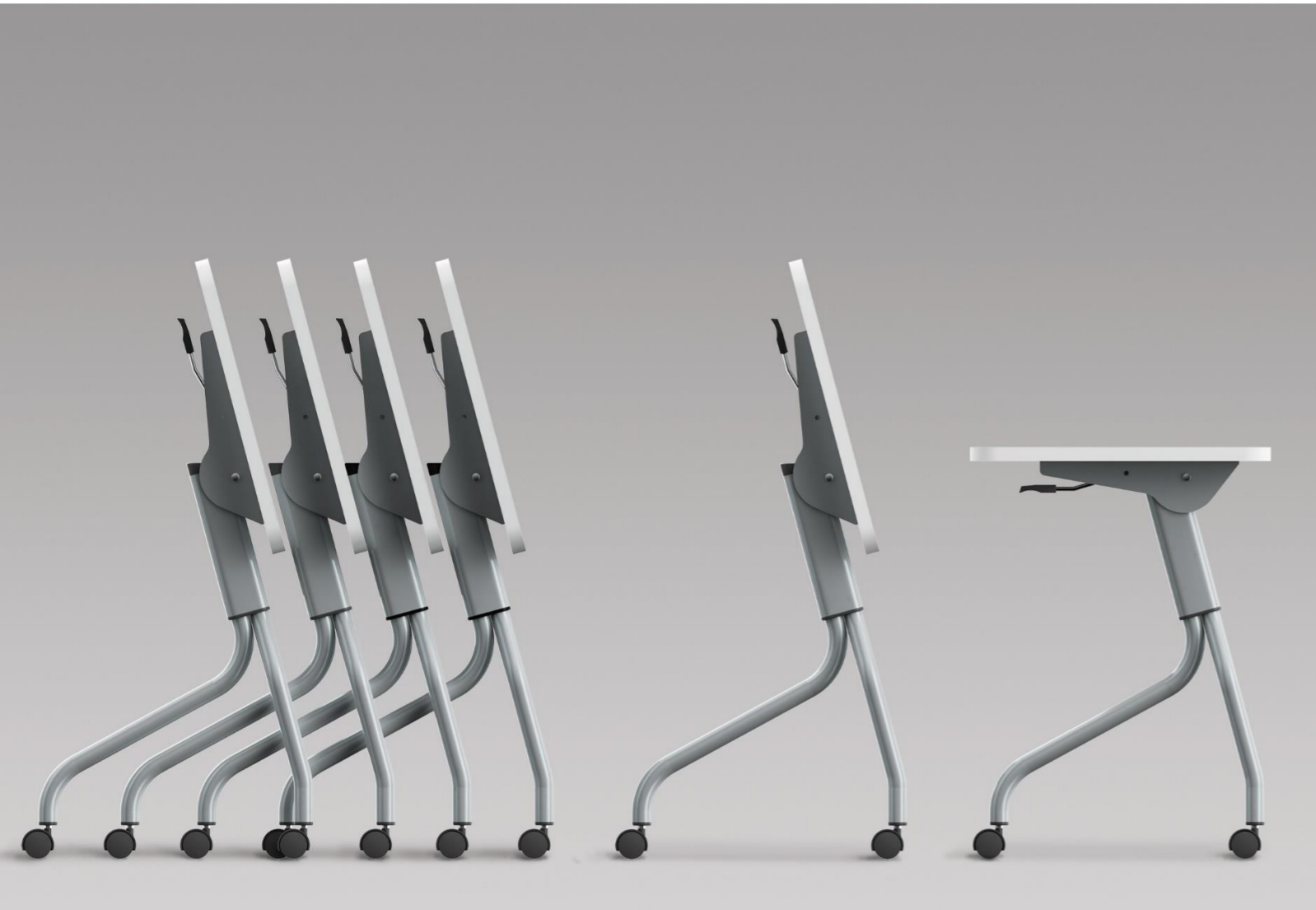

**ZF-09**

Steel specification: 1140 \* 535 \* 725 mm



Colour:



闪银/Silverly pearl



黑无光/Matt Black

ZH-06-4

空间运用

Space transportation

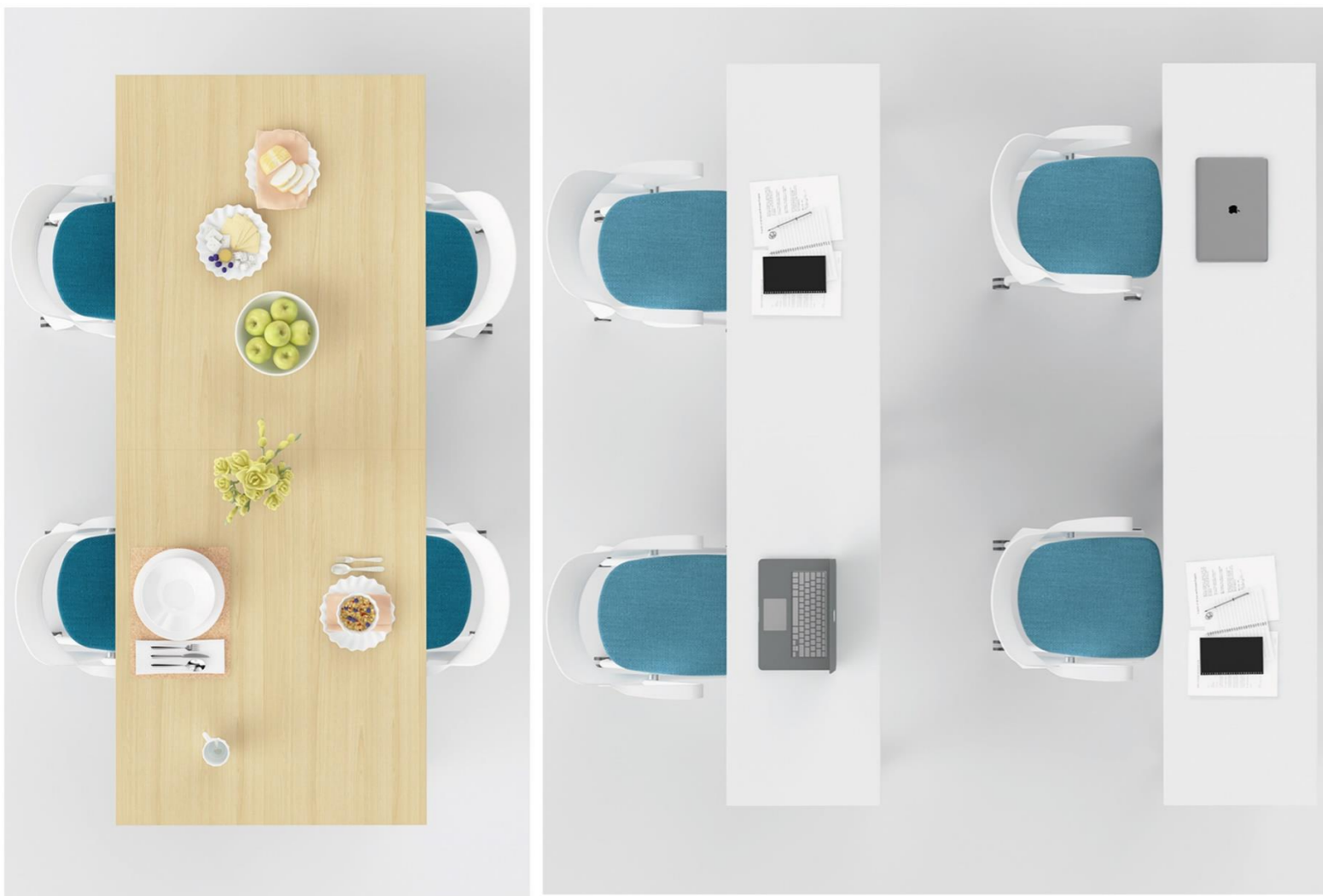

Steel specification: 650 \*725 mm

Top: Elizabeth

Colour:



闪银/Silvery pearl

黑无光/Matt Black



ZH-06-1



Steel specification: 650 \*725 mm

Colour:



闪银/Silvery pearl



黑无光/Matt Black

# FANOM SERIES

CAREFUL DESIGN, UNIQUE INGENUITY



Steel specification: 650 \*725 mm

Colour:



闪银/Silvery pearl



黑无光/Matt Black



ZH-06



ZH-07-01



Steel specification: 650 \*725 mm

Top: Elizabeth

Colour:



闪银/Silvery pearl



黑无光/Matt Black



# Pro-Mix

Creative Space Mix & Match Style



# 空间运用

Space Transportation

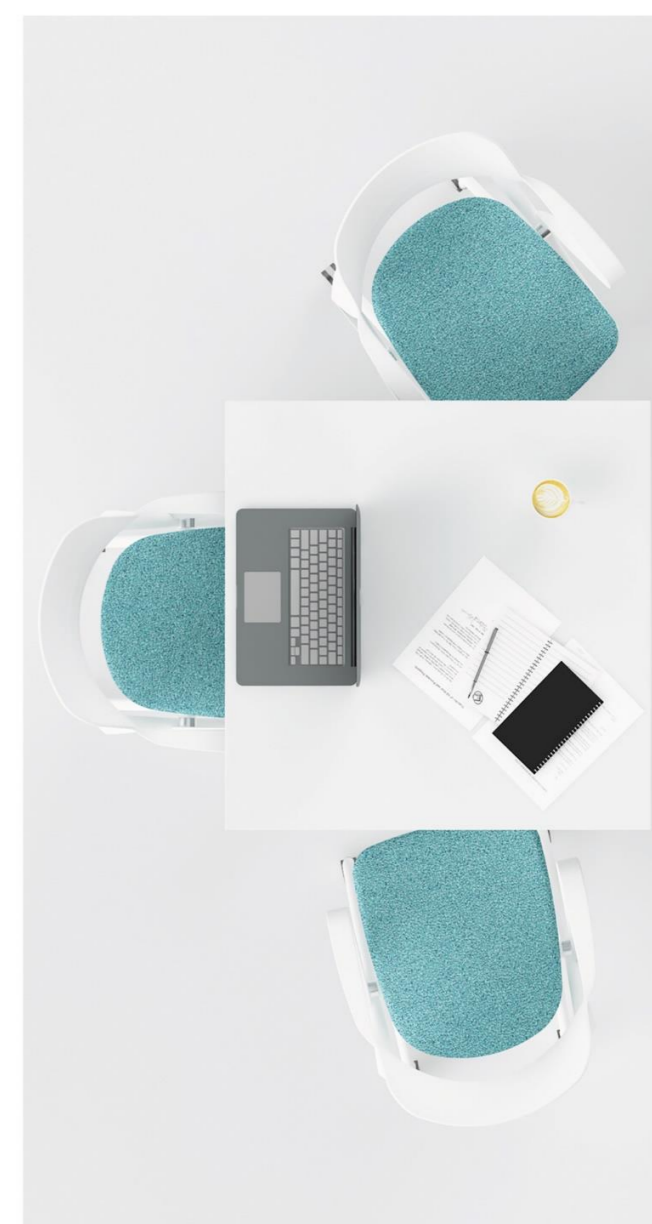
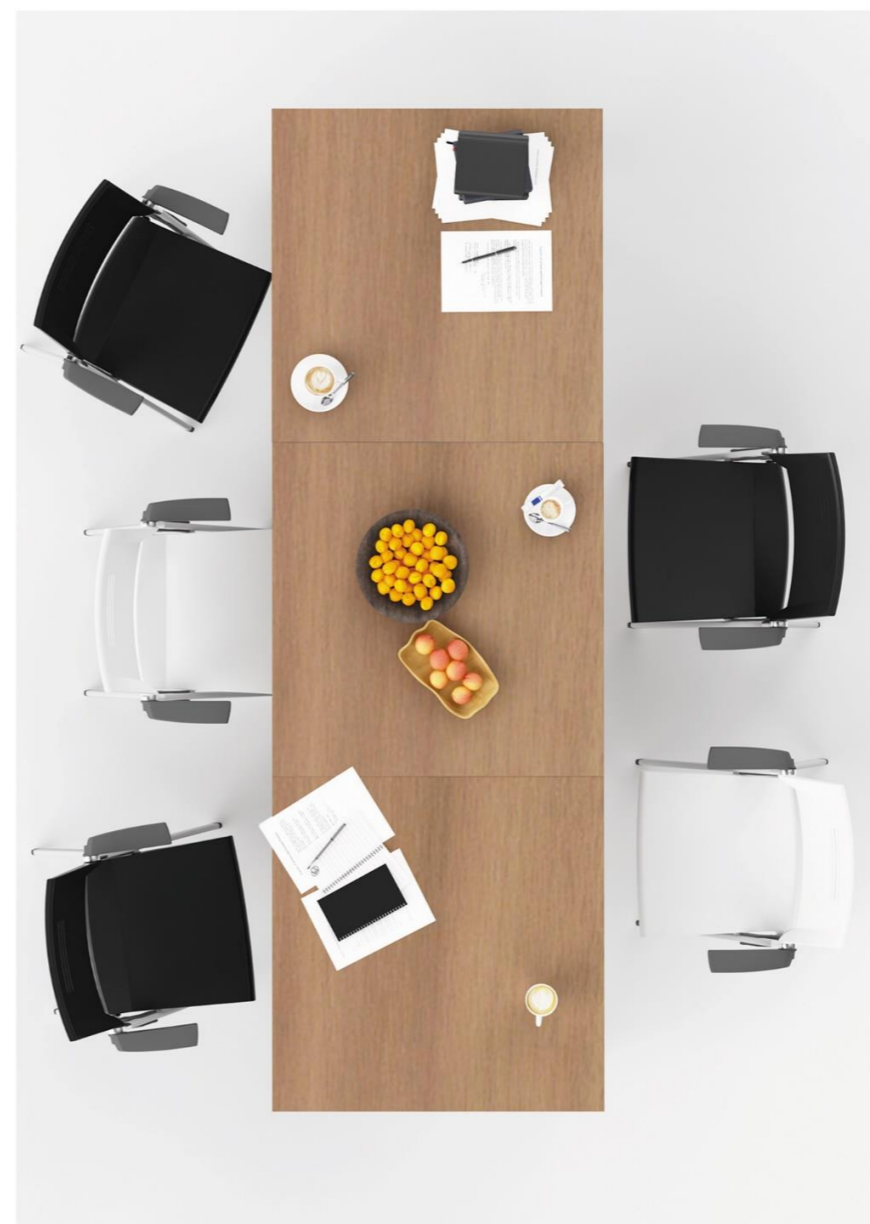

ZK-01



Steel specification: 880\*880 \*725 mm

Top: Elizabeth

Colour:



闪银/Silvery pearl



黑无光/Matt Black

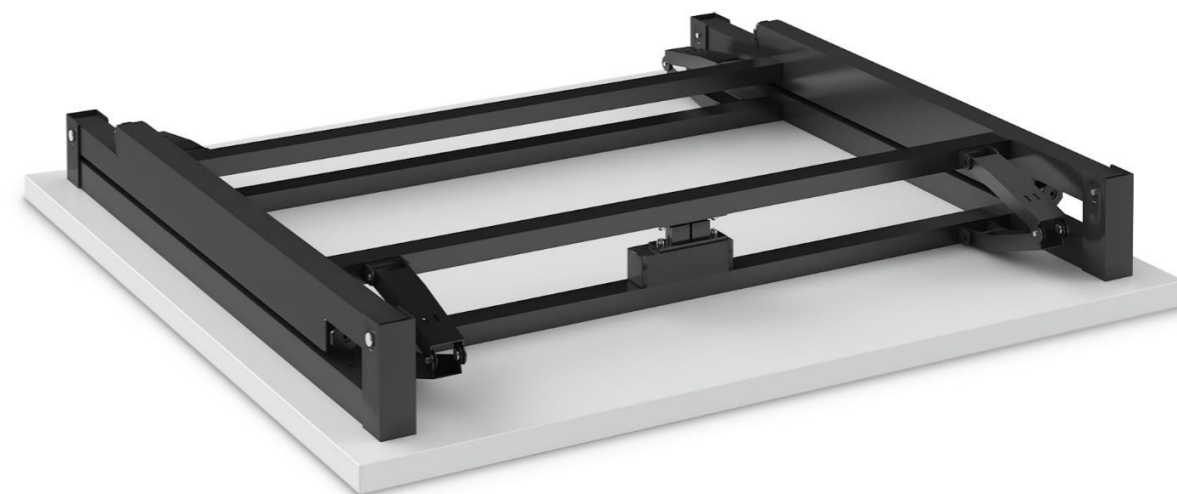

ZK-01

ZK-02



Steel specification: 1100 \*400\*725 mm

Top: Elizabeth

Colour:



闪银/Silvery pearl

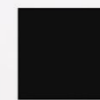

黑无光/Matt Black





ZK-01-03



Steel specification: 1350\*550\*725 mm

Top: Elizabeth

Colour:

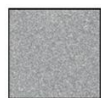

闪银/Silvery pearl



黑无光/Matt Black



ZK-01-03

ZK-01-04



Steel specification: 1350\*550\*725 mm

Top: Elizabeth

Colour:



闪银/Silvery pearl

黑无光/Matt Black



ZK-01-05



Steel specification: 1350\*550\*725 mm

Top: Elizabeth

Colour:



闪银/Silvery pearl

黑无光/Matt Black



ZK-01-06



Steel specification: 1350\*550\*725 mm

Top: Elizabeth

Colour:

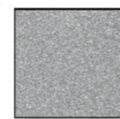

闪银/Silvery pearl



黑无光/Matt Black

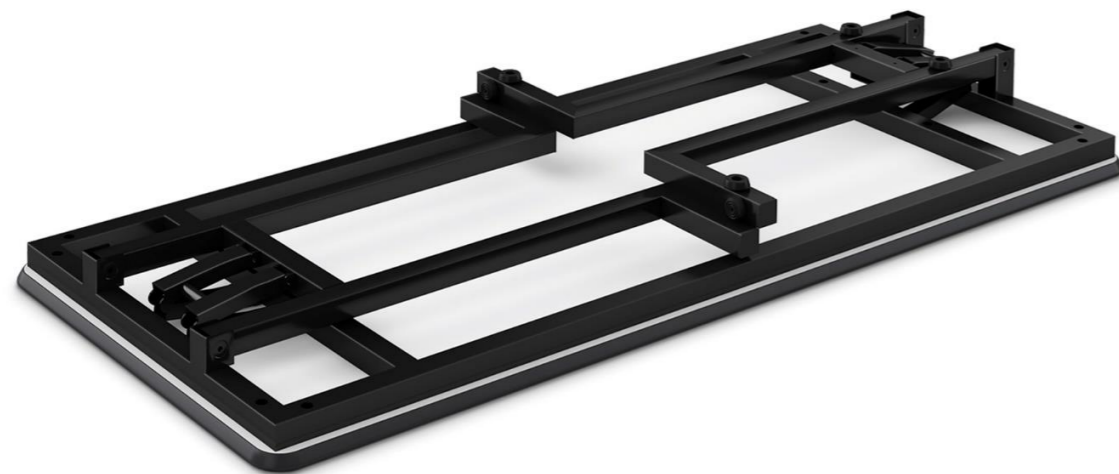

# Concise And refined

Perfect in the details, to cater to the trend of the times And the aesthetic tendency of modern people.

The extraordinary creativity is due to the low-key relaxation, Creating a new concept of office concept.