



Armrest Series



PP ARMREST SERIES

AR-01

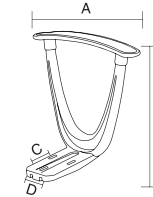

Material: PP
Size: (mm) A = 285 B = 265
 C = 55 D = 54

QTY/CTN	N.W/CTN	G.W/CTN	CARTON BOX SIZE
10 Pairs	17.00	18.00	60x40x28(cm)

AR-03

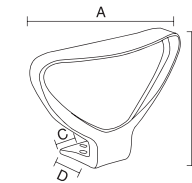

Material: PP
Size: (mm) A = 300 B = 240
 C = 52 D = 53

QTY/CTN	N.W/CTN	G.W/CTN	CARTON BOX SIZE
10 Pairs	12.80	13.80	61x35x27(cm)

AR-05

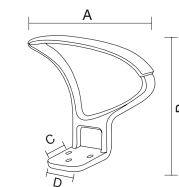

Material: PP
Size: (mm) A = 300 B = 250
 C = 40 D = 58

QTY/CTN	N.W/CTN	G.W/CTN	CARTON BOX SIZE
5 Pairs	6.80	7.80	51x32x22(cm)



PP ARMREST SERIES

AR-06

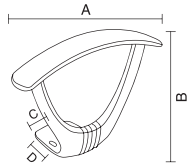

Material: PP
Size: (mm) A = 295 B = 235
 C = 67 D = 40

QTY/CTN	N.W/CTN	G.W/CTN	CARTON BOX SIZE
10 Pairs	12.20	13.20	61x35x28(cm)

AR-07

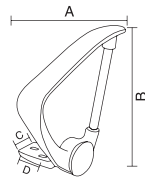

Material: PP
Size: (mm) A = 335 B = 315
 C = 45 D = 42

QTY/CTN	N.W/CTN	G.W/CTN	CARTON BOX SIZE
10 Pairs	15.60	16.60	70x33x35(cm)

AR-08

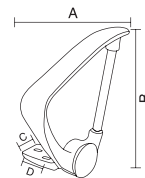

Material: PP
Size: (mm) A = 335 B = 315
 C = 45 D = 42

QTY/CTN	N.W/CTN	G.W/CTN	CARTON BOX SIZE
10 Pairs	17.8	18.8	70x33x35(cm)



PP ARMREST SERIES

AR-09

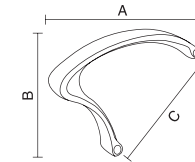

Material: PP
Size: (mm) A = 390 B = 260
 C = 300

QTY/CTN	N.W/CTN	G.W/CTN	CARTON BOX SIZE
5 Pairs	7.80	8.50	41x25x28(cm)

AR-10

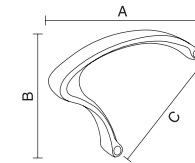

Material: PP
Size: (mm) A = 390 B = 260
 C = 300

QTY/CTN	N.W/CTN	G.W/CTN	CARTON BOX SIZE
5 Pairs	7.50	8.20	41x25x28(cm)

AR-11

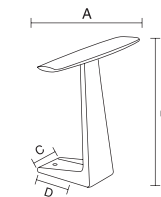

Material: PP
Size: (mm) A = 260 B = 265
 C = 36 D = 67

QTY/CTN	N.W/CTN	G.W/CTN	CARTON BOX SIZE
10 Pairs	13.00	14.00	45x35x28(cm)



PP ARMREST SERIES

AR-12

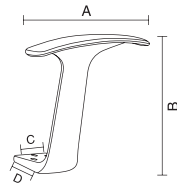

Material: PP
Size: (mm) A = 265 B = 240
 C = 54 D = 54

QTY/CTN	N.W/CTN	G.W/CTN	CARTON BOX SIZE
5 Pairs	8.00	9.00	40x29x24(cm)

AR-13

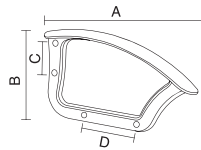

Material: PP
Size: (mm) A = 430 B = 240
 C = 65 D = 140

QTY/CTN	N.W/CTN	G.W/CTN	CARTON BOX SIZE
5 Pairs	9.00	10.00	47x27x29(cm)

AR-14

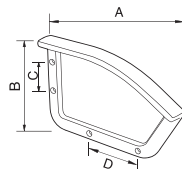

Material: PP
Size: (mm) A = 405 B = 205
 C = 80 D = 145

QTY/CTN	N.W/CTN	G.W/CTN	CARTON BOX SIZE
5 Pairs	12.00	13.00	43.5x34.5x30(cm)



PP ARMREST SERIES

AR-15

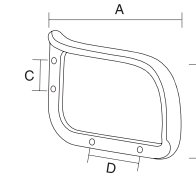

Material: PP
Size: (mm) A = 400 B = 275
 C = 80 D = 155

QTY/CTN	N.W/CTN	G.W/CTN	CARTON BOX SIZE
5 Pairs	13.00	14.00	46x35x30(cm)

AR-16 PU Arm

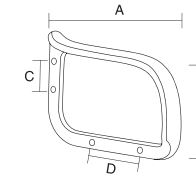

Material: PP
Size: (mm) A = 400 B = 275
 C = 80 D = 155

QTY/CTN	N.W/CTN	G.W/CTN	CARTON BOX SIZE
5 Pairs	8.00	9.00	44x30x28(cm)

AR-17

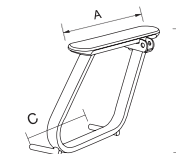

Material: PP
Size: (mm) A = 280 B = 247
 C = 195

QTY/CTN	N.W/CTN	G.W/CTN	CARTON BOX SIZE
10 pcs	15.00	15.80	45x38x27(cm)



PP ARMREST SERIES

AR-23

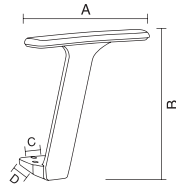

Material: PP
Size: (mm) A = 252 B = 285
 C = 32 D = 55

QTY/CTN	N.W/CTN	G.W/CTN	CARTON BOX SIZE
5 Pairs	8.50	9.20	39x31x30(cm)

AR-056

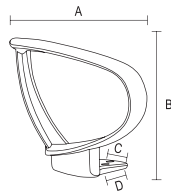

Material: PP
Size: (mm) A = 300 B = 250
 C = 50 D = 54

QTY/CTN	N.W/CTN	G.W/CTN	CARTON BOX SIZE
5 Pairs	8.70	9.30	53x32x26(cm)

AR-19 (MOQ: 500 pairs)

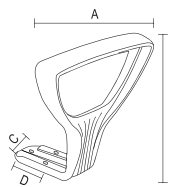

Material: PP
Size: (mm) A = 285 B = 255
 C = 50 D = 55

QTY/CTN	N.W/CTN	G.W/CTN	CARTON BOX SIZE
5 Pairs	7.00	8.00	47x47x25(cm)



ADJUSTABLE ARMREST SERIES

AD-01 (3D function)

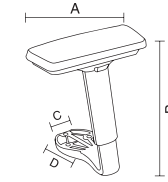

Material: Nylon+PU
Size: (mm) A = 240 B = 240~350
 C = 50 D = 50

QTY/CTN	N.W/CTN	G.W/CTN	CARTON BOX SIZE
4 Pairs	8.00	8.50	37x37x24(cm)

AD-02 (3D function)

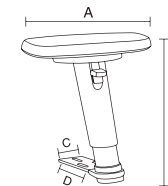

Material: Nylon+PU+metal
Size: (mm) A = 255 B = 280~370
 C = 30 D = 50

QTY/CTN	N.W/CTN	G.W/CTN	CARTON BOX SIZE
5 Pairs	7.00	8.00	47x47x25(cm)

AD-12A (4D function)

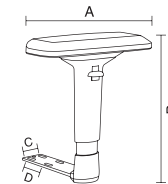

Material: Nylon+PU+metal
Size: (mm) A = 270 B = 290~365
 C = 32 D = 57

QTY/CTN	N.W/CTN	G.W/CTN	CARTON BOX SIZE
5 Pairs	15.80	16.60	47x47x25(cm)



ADJUSTABLE ARMREST SERIES

AD-12B (4D function)

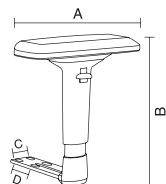

Material: Nylon+PU+metal
Size: (mm) A = 270 B = 290~365
 C = 32 D = 57

QTY/CTN	N.W/CTN	G.W/CTN	CARTON BOX SIZE
5 Pairs	15.80	16.60	47x47x25(cm)

ADJUSTABLE ARMREST SERIES

AD-18B

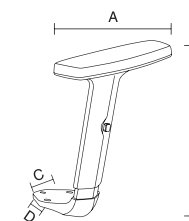

Material: Nylon+PU
Size: (mm) A = 240 B = 280~380
 C = 51 D = 50

QTY/CTN	N.W/CTN	G.W/CTN	CARTON BOX SIZE
Arm: 10 Pairs	12.00	12.50	57x37x19(cm)
PU pad: 20 Pairs	13.00	13.80	61x26x19(cm)

AD-17A (3D function)

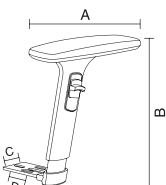

Material: Nylon+PU+metal
Size: (mm) A = 250 B = 280~335
 C = 32 D = 50

QTY/CTN	N.W/CTN	G.W/CTN	CARTON BOX SIZE
5 Pairs	6.00	7.00	47x47x25(cm)

AD-18C

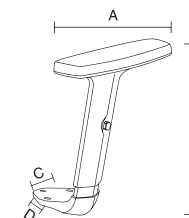

Material: Nylon+PU
Size: (mm) A = 260 B = 280~380
 C = 51 D = 50

QTY/CTN	N.W/CTN	G.W/CTN	CARTON BOX SIZE
Arm: 10 Pairs	12.00	12.50	57x37x19(cm)
PU pad: 20 Pairs	13.00	13.80	61x26x19(cm)

AD-18A

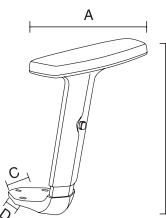

Material: Nylon+PU
Size: (mm) A = 260 B = 280~380
 C = 51 D = 50

QTY/CTN	N.W/CTN	G.W/CTN	CARTON BOX SIZE
Arm: 10 Pairs	12.00	12.50	57x37x19(cm)
PU pad: 20 Pairs	13.00	13.80	61x26x19(cm)

AD-18D

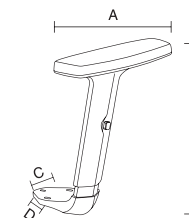

Material: Nylon+PU
Size: (mm) A = 240 B = 280~380
 C = 51 D = 50

QTY/CTN	N.W/CTN	G.W/CTN	CARTON BOX SIZE
Arm: 10 Pairs	12.00	12.50	57x37x19(cm)
PU pad: 20 Pairs	13.00	13.80	61x26x19(cm)

ADJUSTABLE ARMREST SERIES

AD-25

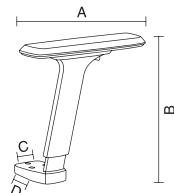

Material: Nylon+PU
Size: (mm) A = 245 B = 260
 C = 32/38 D = 50

QTY/CTN	N.W/CTN	G.W/CTN	CARTON BOX SIZE
5 Pairs	9.00	9.50	37x36x23(cm)

AD-27A

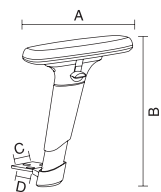

Material: Nylon+metal
Size: (mm) A = 255 B = 300~380
 C = 32 D = 50

QTY/CTN	N.W/CTN	G.W/CTN	CARTON BOX SIZE
5 Pairs	15.1	15.8	46x46x25(cm)

AD-30 (3D function)

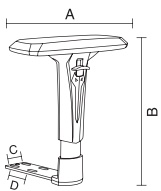

Material: Nylon+PU+metal
Size: (mm) A = 260 B = 280~353
 C = 30 D = 57

QTY/CTN	N.W/CTN	G.W/CTN	CARTON BOX SIZE
5 Pairs	14.0	14.80	47x47x25(cm)



ADJUSTABLE ARMREST SERIES

AD-31 (3D function)

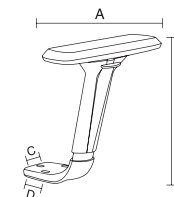

Material: PP+Glass fiber
Size: (mm) A = 260 B = 275~345
 C = 48 D = 51

QTY/CTN	N.W/CTN	G.W/CTN	CARTON BOX SIZE
5 Pairs	12.35	13.35	38x38x25(cm)

AD-08A

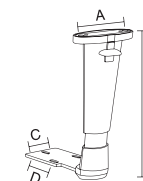

Material: Nylon+metal
Size: (mm) A = 100 B = 255~325
 C = 32 D = 50

QTY/CTN	N.W/CTN	G.W/CTN	CARTON BOX SIZE
10 Pairs	22.00	23.00	39x31.5x32(cm)

AD-08B

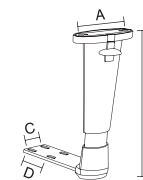

Material: Nylon+metal
Size: (mm) A = 100 B = 255~325
 C = 32 D = 50

QTY/CTN	N.W/CTN	G.W/CTN	CARTON BOX SIZE
10 Pairs	22.00	23.00	39x31.5x32(cm)



ADJUSTABLE ARMREST SERIES

AD-07 (2D function)

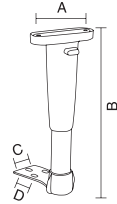

Material: Nylon+metal
Size: (mm) A = 100 B = 250~320
 C = 33 D = 52

QTY/CTN	N.W/CTN	G.W/CTN	CARTON BOX SIZE
5 Pairs	11.00	12.00	39.5x30.5x19(cm)

ADJUSTABLE ARMREST SERIES

AD-10

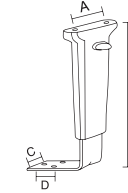

Material: Nylon+metal
Size: (mm) A = 100 B = 220~290
 C = 33 D = 50

QTY/CTN	N.W/CTN	G.W/CTN	CARTON BOX SIZE
10 Pairs	19.80	20.80	46x33x17(cm)

AD-09A

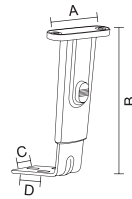

Material: Nylon+metal
Size: (mm) A = 100 B = 250~320
 C = 32 D = 50

QTY/CTN	N.W/CTN	G.W/CTN	CARTON BOX SIZE
10 Pairs	22.00	23.00	47x32x21(cm)

AD-11A

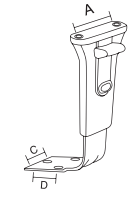

Material: Nylon+metal
Size: (mm) A = 100 B = 250~315
 C = 54 D = 54

QTY/CTN	N.W/CTN	G.W/CTN	CARTON BOX SIZE
10 Pairs	22.00	23.00	51x28x25(cm)

AD-09B

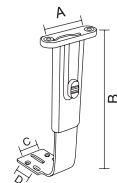

Material: Nylon+metal
Size: (mm) A = 100 B = 260~330
 C = 54 D = 54

QTY/CTN	N.W/CTN	G.W/CTN	CARTON BOX SIZE
10 Pairs	20.00	21.00	47x32x21(cm)

AD-11B



Material: Nylon+metal
Size: (mm) A = 100 B = 250~315
 C = 34 D = 54

QTY/CTN	N.W/CTN	G.W/CTN	CARTON BOX SIZE
10 Pairs	20.00	21.00	47x32x21(cm)

ADJUSTABLE ARMREST SERIES

AD-27

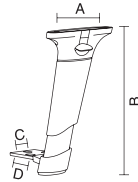

Material: Nylon+metal
Size: (mm) A = 100 B = 260~350
 C = 32 D = 50

QTY/CTN	N.W/CTN	G.W/CTN	CARTON BOX SIZE
5 Pairs	9.70	10.20	38x32x18(cm)

AD-13

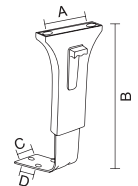

Material: Nylon+metal
Size: (mm) A = 100 B = 250~315
 C = 34/54 D = 54

QTY/CTN	N.W/CTN	G.W/CTN	CARTON BOX SIZE
10 Pairs	22.00	23.00	45x32x20(cm)

AD-15

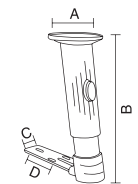

Material: Nylon+metal
Size: (mm) A = 100 B = 285~360
 C = 40 D = 55

QTY/CTN	N.W/CTN	G.W/CTN	CARTON BOX SIZE
10 Pairs	18.00	19.00	53x32x22(cm)



PU ARM PADS SERIES

AP-PU01

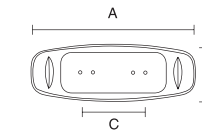

Main material: PU
Size: (mm) A = 250 B = 90
 C = 100

QTY/CTN	N.W/CTN	G.W/CTN	CARTON BOX SIZE
20 Pairs	15.04	16.04	58x26.5x19.5(cm)

AP-PU02

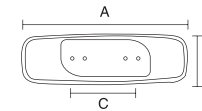

Main material: PU
Size: (mm) A = 250 B = 75
 C = 100

QTY/CTN	N.W/CTN	G.W/CTN	CARTON BOX SIZE
20 Pairs	15.00	16.00	58x26.5x19.5(cm)

AP-PU03

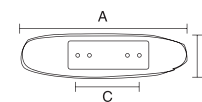

Main material: PU
Size: (mm) A = 280 B = 75
 C = 100

QTY/CTN	N.W/CTN	G.W/CTN	CARTON BOX SIZE
20 Pairs	12.86	13.86	55x29x18(cm)

AP-PU04

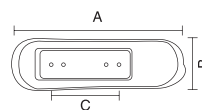

Main material: PU
Size: (mm) A = 250 B = 75
 C = 100

QTY/CTN	N.W/CTN	G.W/CTN	CARTON BOX SIZE
20 Pairs	12.62	13.62	53x45x18(cm)



PU ARM PADS SERIES

Armrest Series

AP-PU05

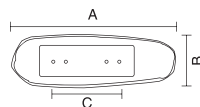

Main material: PU
Size: (mm) A = 250 B = 80
 C = 100

QTY/CTN	N.W/CTN	G.W/CTN	CARTON BOX SIZE
20 Pairs	11.70	12.70	51x40x18(cm)

AP-PU06

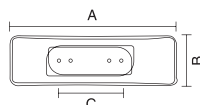

Main material: PU
Size: (mm) A = 260 B = 75
 C = 100

QTY/CTN	N.W/CTN	G.W/CTN	CARTON BOX SIZE
20 Pairs	14.64	15.64	50x28x18(cm)

AP-PU07

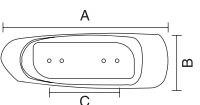

Main material: PU
Size: (mm) A = 245 B = 80
 C = 100

QTY/CTN	N.W/CTN	G.W/CTN	CARTON BOX SIZE
20 Pairs	11.08	12.08	51x32x19.5(cm)

AP-PU10

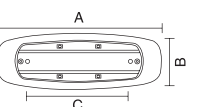

Main material: PU
Size: (mm) A = 250 B = 85
 C = 110

QTY/CTN	N.W/CTN	G.W/CTN	CARTON BOX SIZE
20 Pairs	15.00	16.00	29x30x34(cm)

PU ARM PADS SERIES

Armrest Series

AP-PU11

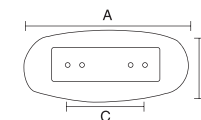

Main material: PU
Size: (mm) A = 220 B = 62
 C = 100

QTY/CTN	N.W/CTN	G.W/CTN	CARTON BOX SIZE
20 Pairs	11.40	12.40	43x37.5x20.5(cm)

AP-PU12

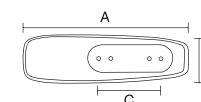

Main material: PU
Size: (mm) A = 265 B = 80
 C = 100

QTY/CTN	N.W/CTN	G.W/CTN	CARTON BOX SIZE
20 Pairs	15.00	16.00	58x26.5x19.5(cm)

AP-PU13

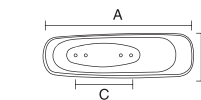

Main material: PU
Size: (mm) A = 270 B = 75
 C = 100

QTY/CTN	N.W/CTN	G.W/CTN	CARTON BOX SIZE
20 Pairs	14.20	15.20	58x26.5x19.5(cm)

AP-PU14

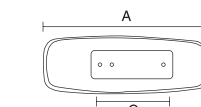

Main material: PU
Size: (mm) A = 270 B = 90
 C = 100

QTY/CTN	N.W/CTN	G.W/CTN	CARTON BOX SIZE
20 Pairs	15.00	16.00	29x30x34(cm)

PU ARM PADS SERIES

AP-PU15

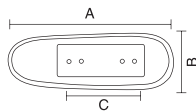

Main material: PU
Size: (mm) A = 230 B = 80
 C = 100

QTY/CTN	N.W/CTN	G.W/CTN	CARTON BOX SIZE
20 Pairs	12.58	13.58	51x43x20(cm)

AP-PU16

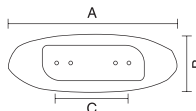

Main material: PU
Size: (mm) A = 230 B = 75
 C = 100

QTY/CTN	N.W/CTN	G.W/CTN	CARTON BOX SIZE
20 Pairs	9.76	10.76	47x25.5x16.5(cm)

AP-PU17

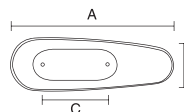

Main material: PU
Size: (mm) A = 250 B = 80
 C = 100

QTY/CTN	N.W/CTN	G.W/CTN	CARTON BOX SIZE
20 Pairs	14.20	15.20	58x26.5x19.5(cm)

AP-PU31

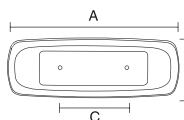

Main material: PU
Size: (mm) A = 250 B = 90
 C = 100

QTY/CTN	N.W/CTN	G.W/CTN	CARTON BOX SIZE
20 Pairs	13.12	14.12	54x42x21(cm)



Backs & Seats Series



MESH BACKS SERIES

MB-GS02

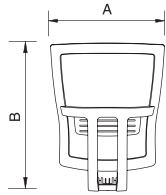

Material: Nylon+Glass fiber
Size: (mm) A = 480 B = 628

QTY/CTN	N.W/CTN	G.W/CTN	CARTON BOX SIZE
5 pcs	14.30	15.30	78x48.5x41(cm)

MB-FS02

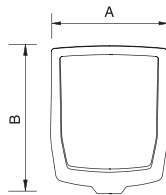

Material: Nylon+Glass fiber
Size: (mm) A = 477 B = 597

QTY/CTN	N.W/CTN	G.W/CTN	CARTON BOX SIZE
5 pcs	8.00	9.00	59x48x25(cm)

MB-FN02

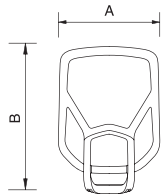

Material: Nylon+Glass fiber
Size: (mm) A = 456 B = 587

QTY/CTN	N.W/CTN	G.W/CTN	CARTON BOX SIZE
5 pcs	11.00	12.00	68.5x62x48(cm)

MB-GR02

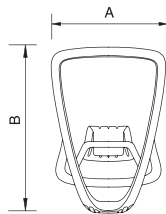

Material: Nylon+Glass fiber
Size: (mm) A = 495 B = 592

QTY/CTN	N.W/CTN	G.W/CTN	CARTON BOX SIZE
5 pcs	10.30	11.30	72x68x50(cm)



MESH BACKS SERIES

MB161-1

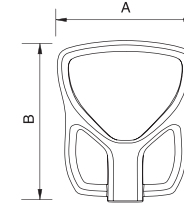

Material: PP+Glass fiber
Size: (mm) A = 493 B = 585

QTY/CTN	N.W/CTN	G.W/CTN	CARTON BOX SIZE
5 pcs	8.20	9.50	66x33x51(cm)

MB-GA02

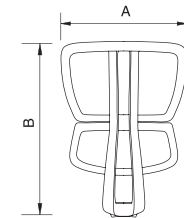

Material: PP+Glass fiber
Size: (mm) A = 510 B = 590

QTY/CTN	N.W/CTN	G.W/CTN	CARTON BOX SIZE
5 pcs	16.50	17.50	78.5x52x44(cm)

MB-07

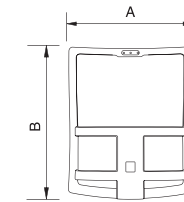

Material: Nylon+Glass fiber
Size: (mm) A = 490 B = 585

QTY/CTN	N.W/CTN	G.W/CTN	CARTON BOX SIZE
10 pcs	19.00	20.00	42x41x54(cm)

MB-08

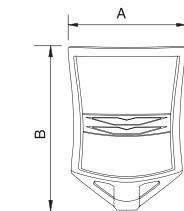

Material: Nylon+Glass fiber
Size: (mm) A = 460 B = 635

QTY/CTN	N.W/CTN	G.W/CTN	CARTON BOX SIZE
6 pcs	12.60	13.60	51x32x67(cm)



MESH BACKS SERIES

MB-01

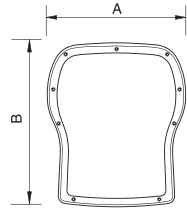

Inner Material: Nylon+Glass fiber
Size: (mm) A = 450 B = 600

QTY/CTN	N.W/CTN	G.W/CTN	CARTON BOX SIZE
Together in below carton			

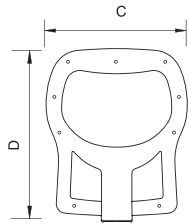

Outer Material: Nylon+Glass fiber
Size: (mm) C = 460 D = 610

QTY/CTN	N.W/CTN	G.W/CTN	CARTON BOX SIZE
5 pcs	15.00	16.00	49x32x65(cm)

MB-1506

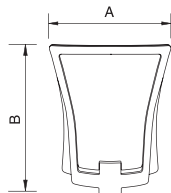

Material: Nylon+Glass fiber
Size: (mm) A = 510 B = 850

QTY/CTN	N.W/CTN	G.W/CTN	CARTON BOX SIZE
5 pcs	8.50	9.50	51x32x66(cm)

MB-10

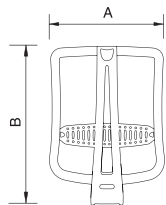

Material: PP+Glass fiber
Size: (mm) A = 495 B = 670

QTY/CTN	N.W/CTN	G.W/CTN	CARTON BOX SIZE
5 pcs	11.80	12.80	66x49x49(cm)



PLASTIC BACKS SERIES

BC-01M

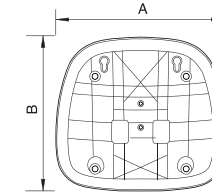

Inner Material: PP
Size: (mm) A = 410 B = 400

QTY/CTN	N.W/CTN	G.W/CTN	CARTON BOX SIZE
25 pcs	10.80	11.80	71.5x42x37.5(cm)

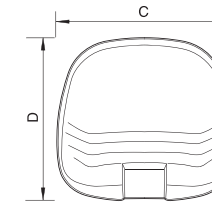

Outer Material: PP
Size: (mm) C = 450 D = 380

QTY/CTN	N.W/CTN	G.W/CTN	CARTON BOX SIZE
25 pcs	12.00	13.00	80.5x43x39(cm)

BC-01H

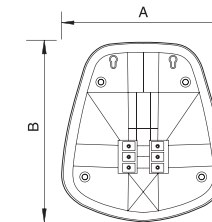

Inner Material: PP
Size: (mm) A = 410 B = 390

QTY/CTN	N.W/CTN	G.W/CTN	CARTON BOX SIZE
20 pcs	13.00	14.00	56.5x43.5x48(cm)

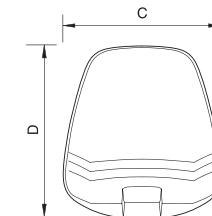

Outer Material: PP
Size: (mm) C = 430 D = 390

QTY/CTN	N.W/CTN	G.W/CTN	CARTON BOX SIZE
20 pcs	12.20	13.00	80x46x50(cm)



PLASTIC BACKS SERIES

BS-02BK

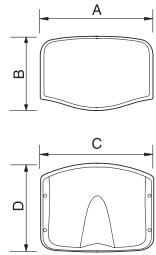

Material: PP

Size: (mm) A = 465 B = 315
C = 465 D = 395

	QTY/CTN	N.W/CTN	G.W/CTN	CARTON BOX SIZE
Back:	30 pcs	14.00	15.00	63x52x32(cm)
Seat:	30 pcs	16.78	17.78	47x46x40.5(cm)

BS-02BL

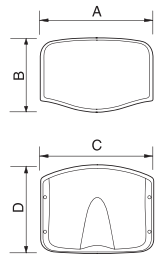

Material: PP

Size: (mm) A = 465 B = 315
C = 465 D = 395

	QTY/CTN	N.W/CTN	G.W/CTN	CARTON BOX SIZE
Back:	30 pcs	14.00	15.00	63x52x32(cm)
Seat:	30 pcs	16.78	17.78	47x46x40.5(cm)

BC-KB02

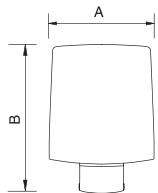

Material: Nylon+Glass fiber

Size: (mm) A = 465 B = 560

ST-KB02

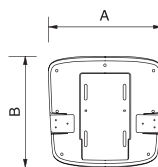

Material: Nylon+Glass fiber

Size: (mm) A = 505 B = 495



SEAT SETS - PLYWOOD SHELLS

ST-01

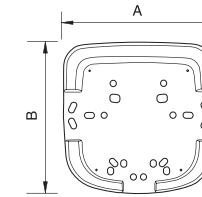

Material: PP

Size: (mm) A = 458 B = 428

QTY/CTN	N.W/CTN	G.W/CTN	CARTON BOX SIZE
40 pcs	16.00	16.90	46x43x62(cm)

ST-01P

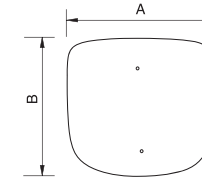

Material: Plywood

Size: (mm) A = 450 B = 415

QTY/CTN	N.W/CTN	G.W/CTN	CBM
10 pcs	10.10	10.40	0.021

ST-02

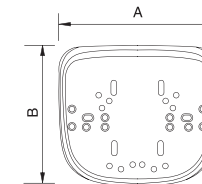

Material: PP

Size: (mm) A = 487 B = 437

QTY/CTN	N.W/CTN	G.W/CTN	CARTON BOX SIZE
50 pcs	27.00	28.00	70x49.5x45(cm)

ST-02P

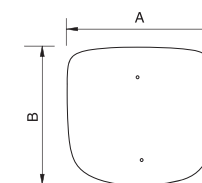

Material: Plywood

Size: (mm) A = 477 B = 430

QTY/CTN	N.W/CTN	G.W/CTN	CBM
10 pcs	12.60	12.70	0.025



SEAT SETS - PLYWOOD SHELLS

ST-03

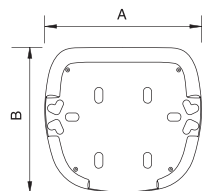

Material: PP
Size: (mm) A = 442 B = 395

QTY/CTN	N.W/CTN	G.W/CTN	CARTON BOX SIZE
50 pcs	18.00	19.00	46x41x49(cm)

ST-03P

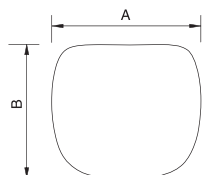

Material: Plywood
Size: (mm) A = 432 B = 385

QTY/CTN	N.W/CTN	G.W/CTN	CBM
10 pcs	7.50	7.80	0.020

ST-04

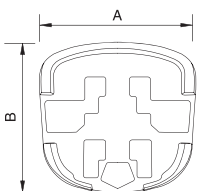

Material: PP
Size: (mm) A = 486 B = 465

QTY/CTN	N.W/CTN	G.W/CTN	CARTON BOX SIZE
50 pcs			72x48x48(cm)

ST-04P

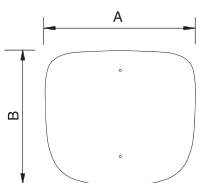

Material: Plywood
Size: (mm) A = 484 B = 460

QTY/CTN	N.W/CTN	G.W/CTN	CBM
10 pcs	15.80	15.90	0.028



SEAT SETS - PLYWOOD SHELLS

ST-05

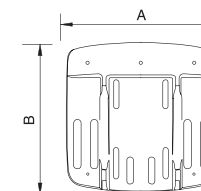

Material: PP
Size: (mm) A = 462 B = 442

QTY/CTN	N.W/CTN	G.W/CTN	CARTON BOX SIZE
20 pcs	12.50	13.50	66.5x47x46.5(cm)

ST-05P

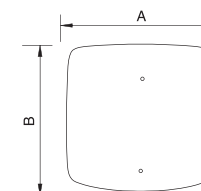

Material: Plywood
Size: (mm) A = 452 B = 432

QTY/CTN	N.W/CTN	G.W/CTN	CBM
10 pcs	12.40	12.50	0.028

ST-06

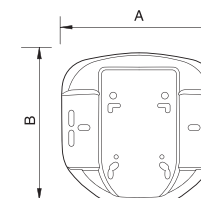

Material: PP
Size: (mm) A = 475 B = 465

QTY/CTN	N.W/CTN	G.W/CTN	CARTON BOX SIZE
25 pcs	12.50	13.50	47x46x48(cm)

ST-06P

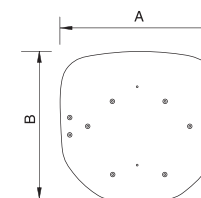

Material: Plywood (12.0mm)
Size: (mm) A = 465 B = 455

QTY/CTN	N.W/CTN	G.W/CTN	CBM
10 pcs	11.80	11.90	0.028



SEAT SETS - PLYWOOD SHELLS

ST-2001

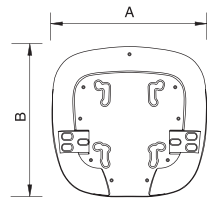

Material: PP
Size: (mm) A = 497 B = 470

QTY/CTN	N.W/CTN	G.W/CTN	CARTON BOX SIZE
20 pcs	14.00	15.00	

ST-2001P

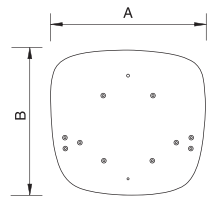

Material: Plywood
Size: (mm) A = 495 B = 450

QTY/CTN	N.W/CTN	G.W/CTN	CBM
10 pcs	15.20	15.30	0.029

ST-GS

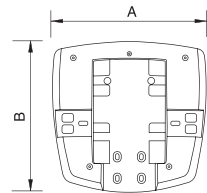

Material: PP
Size: (mm) A = 499 B = 474

QTY/CTN	N.W/CTN	G.W/CTN	CARTON BOX SIZE
20 pcs	10.00	11.00	

ST-GSP

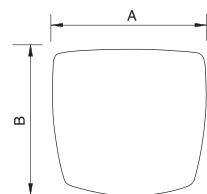

Material: Plywood
Size: (mm) A = 488 B = 463

QTY/CTN	N.W/CTN	G.W/CTN	CBM
10 pcs	14.20	14.30	0.027



SEAT SETS - PLYWOOD SHELLS

ST-08

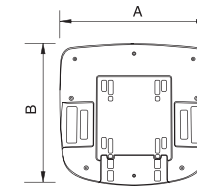

Material: PP
Size: (mm) A = 498 B = 485

QTY/CTN	N.W/CTN	G.W/CTN	CBM
20 pcs	12.40	13.30	0.078

ST-08P

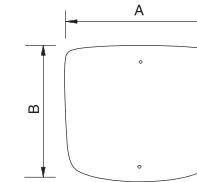

Material: Plywood
Size: (mm) A = 483 B = 476

QTY/CTN	N.W/CTN	G.W/CTN	CBM
10 pcs	15.00	15.10	0.029

ST-09

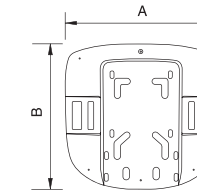

Material: PP
Size: (mm) A = 506 B = 478

QTY/CTN	N.W/CTN	G.W/CTN	CARTON BOX SIZE
25 pcs	16.00	17.00	

ST-09P

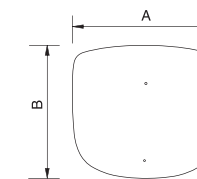

Material: Plywood
Size: (mm) A = 500 B = 468

QTY/CTN	N.W/CTN	G.W/CTN	CBM
10 pcs	15.60	15.70	0.029



SEAT SETS - PLYWOOD SHELLS

WD-01M

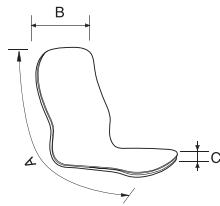

Material: Plywood
Size: (mm) A = 1030 B = 530
 C = Single layer 12mm
 Double layer 16mm
 (11外+5内)

QTY/CTN	N.W/CTN	G.W/CTN	CBM
3 pcs	17.10	17.20	0.038

WD-01H

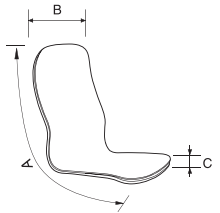

Material: Plywood
Size: (mm) A = 1180 B = 520
 C = Single layer 12mm
 Double layer 16mm
 (11外+5内)

QTY/CTN	N.W/CTN	G.W/CTN	CBM
3 pcs	18.90	19.00	0.047

WD-02H

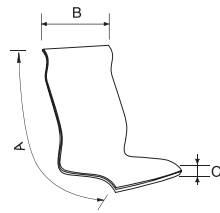

Material: Plywood
Size: (mm) A = 1350 B = 535
 C = Double layer 16mm

QTY/CTN	N.W/CTN	G.W/CTN	CBM
2 pcs	13.40	13.50	0.048



Nylon Bases Series



NYLON BASES

PA-A

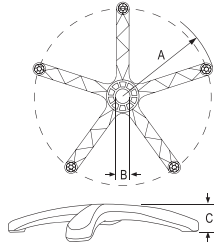

Material: Nylon+Glass Fiber

(mm)

ITEM NO.	A	B	C	QTY/CTN	N.W.	G.W.	CBM
A250	250	50.8	46	5pcs	4.4	4.9	0.026
A270	270	50.8	50	5pcs	5.2	5.7	0.3
A280	280	50.8	52	5pcs	5.5	6.0	0.036
A300	300	50.8	58	5pcs	6.8	7.3	0.05
A320	320	50.8	65	5pcs	7.2	7.9	0.06
A350	350	50.8	72	5pcs	7.2	7.9	0.07

NYLON BASES

PA-K300(BK) / PA-K320(BK)

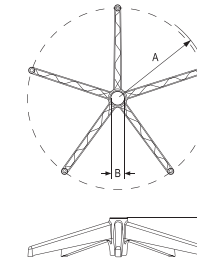

Material: Nylon+Glass Fiber

(mm)

ITEM NO.	A	B	C	QTY/CTN	N.W.	G.W.	CBM
PA-K300(BK)	300	50	68	5PCS	7.6	8.2	0.045
PA-K320(BK)	320	50	70	5PCS	8.35	8.95	0.056

PA-B

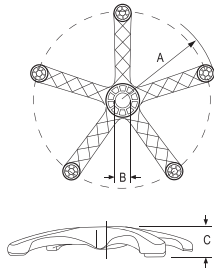

Material: Nylon+Glass Fiber

(mm)

ITEM NO.	A	B	C	QTY/CTN	N.W.	G.W.	CBM
B300	300	50.8	66	5pcs	7.1	7.7	0.045
B320	320	50.8	68	5pcs	9.2	9.8	0.054
B350	350	50.8	72	5pcs	9.7	10.4	0.067

PA-K300(WT) / PA-K320(WT)

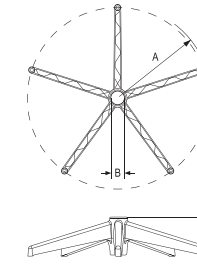

Material: Nylon+Glass Fiber

(mm)

ITEM NO.	A	B	C	QTY/CTN	N.W.	G.W.	CBM
PA-K300(WT)	300	50	68	5PCS	7.5	8.1	0.045
PA-K320(WT)	320	50	70	5PCS	8.25	8.85	0.056

PA-D

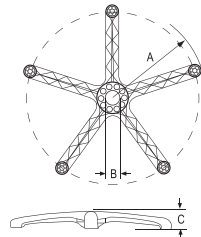

Material: Nylon+Glass Fiber

(mm)

ITEM NO.	A	B	C	QTY/CTN	N.W.	G.W.	CBM
D280	280	50.8	64	5pcs	6.1	6.7	0.037
D300	300	50.8	66	5pcs	7.1	7.7	0.045
D320	320	50.8	68	5pcs	9.2	9.8	0.054
D350	350	50.8	72	5pcs	9.7	10.4	0.067

PA-G

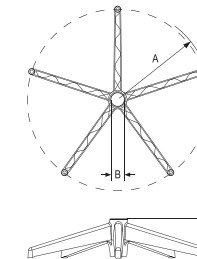

Material: Nylon+Glass Fiber

(mm)

ITEM NO.	A	B	C	QTY/CTN	N.W.	G.W.	CBM
G340	340	50.8	140	3pcs	5.7	6.5	0.078

NYLON BASES

PA-N320 / PA-N340

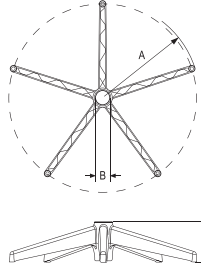

Material: Nylon+Glass Fiber

(mm)

ITEM NO.	A	B	C	QTY/CTN	N.W.	G.W.	CBM
N320	320	50.8	72	5pcs	7.5	8.3	0.067
N340	340	50.8	80.6	5pcs	8.0	8.8	0.083

PA-Q350

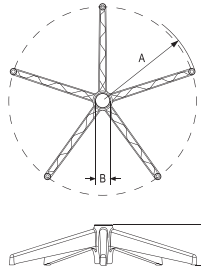

Material: Nylon+Glass Fiber

(mm)

ITEM NO.	A	B	C	QTY/CTN	N.W.	G.W.	CBM
Q350	350	50.8	76	5pcs	9.0	9.6	0.072



Aluminium Bases Series

ALUMINIUM BASES

ALB-01

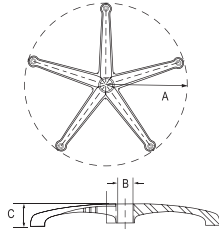

Material: Aluminium

(mm)

ITEM NO.	A	B	C	QTY/CTN	N.W.	G.W.	CBM
ALB-01-350	350	50	60	5pcs	7.50	8.30	0.68
ALB-01-330	330	50	60	5pcs	8.60	9.20	0.80

ALB-02

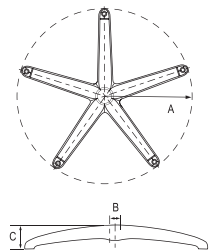

Material: Aluminium

(mm)

ITEM NO.	A	B	C	QTY/CTN	N.W.	G.W.	CBM
ALB-02-350	350	50	60	5pcs	8.8	9.3	0.071
ALB-02-330	330	50	60	5pcs	8.6	9.5	0.088
ALB-02-300	307	50	60	5pcs	7.5	8.1	0.048

ALB-SH13/330 / ALB-SH13/350

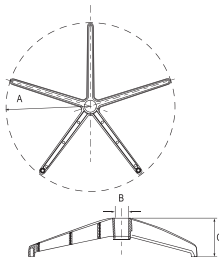

Material: Aluminium

(mm)

ITEM NO.	A	B	C	QTY/CTN	N.W.	G.W.	CBM
ALB-SH13/330	330	50	60	5pcs	8.0	8.8	0.072
ALB-SH13/350	350	50	65	5pcs	9.0	9.8	0.082



ALUMINIUM BASES

ALB-K320 / ALB-K350

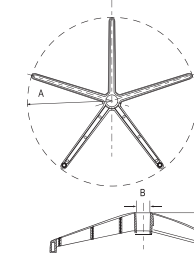

Material: Aluminium

(mm)

ITEM NO.	A	B	C	QTY/CTN	N.W.	G.W.	CBM
ALB-K320	320	50	80	5pcs	7.50	8.5	0.062
ALB-K350	350	50	80	5pcs	8.50	9.50	0.068

ALB-SH02-330

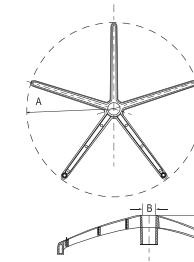

Material: Aluminium

(mm)

ITEM NO.	A	B	C	QTY/CTN	N.W.	G.W.	CBM
ALB-SH02-330	330	50	110	5pcs	8.0	8.8	0.097

ALB-MK340

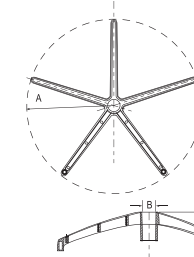

Material: Aluminium

(mm)

ITEM NO.	A	B	C	QTY/CTN	N.W.	G.W.	CBM
ALB-MK340	340	50	130	5pcs	10.3	13.1	0.088



ALUMINIUM BASES

ALB-09

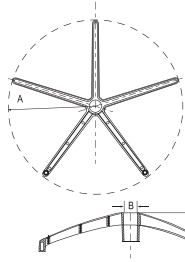

Material: Aluminium

(mm)

ITEM NO.	A	B	C	QTY/CTN	N.W.	G.W.	CBM
ALB-09-340	340	50	70	5pcs	10.5	11.3	0.093

ALB-10

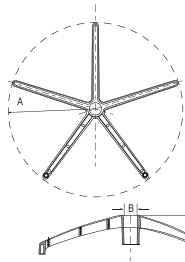

Material: Aluminium

(mm)

ITEM NO.	A	B	C	QTY/CTN	N.W.	G.W.	CBM
ALB-10-330	330	50	70	5pcs			0.088

CHROMED BASES

IRB-01

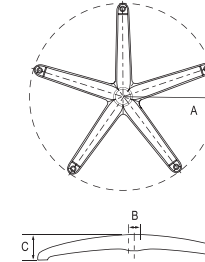

Material: Iron

Thickness: 1.2mm / 1.5mm

(mm)

ITEM NO.	A	B	C	QTY/CTN	N.W.	G.W.	CBM
IRB-01-350	350	50	125	5pcs	12.10	12.90	0.078
IRB-01-320	320	50	125	5pcs	10.60	11.20	0.061
IRB-01-300	300	50	125	5pcs	8.00	8.80	0.053

IRB-02

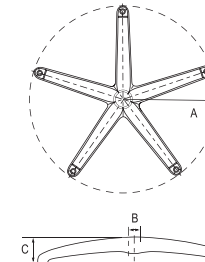

Material: Iron

Thickness: 1.2mm / 1.5mm

(mm)

ITEM NO.	A	B	C	QTY/CTN	N.W.	G.W.	CBM
IRB-02-350	350	50	105	5pcs	12.10	12.90	0.081
IRB-02-320	320	50	105	5pcs	10.60	11.20	0.063
IRB-02-300	300	50	105	5pcs	8.00	8.80	0.055

IRB-02 BK Black powder coating (MOQ: 500 pairs)

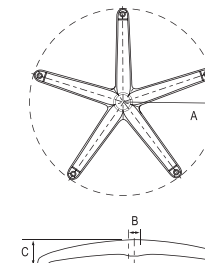

Material: Iron

Thickness: 1.2mm / 1.5mm

(mm)

ITEM NO.	A	B	C	QTY/CTN	N.W.	G.W.	CBM
IRB-02-350	350	50	105	5pcs	12.10	12.90	0.081
IRB-02-320	320	50	105	5pcs	10.60	11.20	0.063
IRB-02-300	300	50	105	5pcs	8.00	8.80	0.055

CHROMED BASES

IRB-04

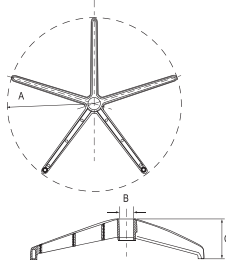

Material: Iron
Thickness: 1.2mm

(mm)

ITEM NO.	A	B	C	QTY/CTN	N.W.	G.W.	CBM
IRB-04-350	350	50	314	5pcs	10.5	11.3	0.085
IRB-04-320	320	50	314	5pcs	9.6	10.2	0.08
IRB-04-300	300	50	314	5pcs	8.8	9.6	0.072

IRB-05

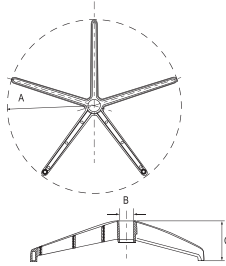

Material: Iron
Thickness: 1.2mm

(mm)

ITEM NO.	A	B	C	QTY/CTN	N.W.	G.W.	CBM
IRB-05-340	320	50	138	5pcs	10.75	11.55	0.088
IRB-05-320	300	50	138	5pcs	10.0	10.8	0.074

CHROMED BASES

Frame 1001

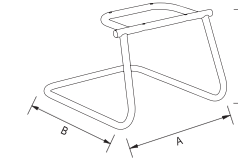

Material: Iron
Thickness: 2.0mm

Size: A = 480 B = 600
C = 380

QTY/CTN	N.W/CTN	G.W/CTN	CBM
5 pcs	21.4	21.5	0.105

Frame 1005

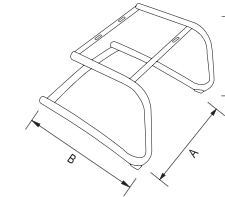

Material: Iron
Thickness: 1.5mm double layer

Size: A = 480 B = 600
C = 380

QTY/CTN	N.W/CTN	G.W/CTN	CBM
5 pcs	13.9	14.0	0.105

FOOTRINGS

FT-01

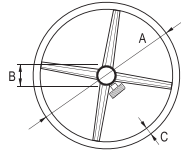

Material: Aluminium cross + Chromed ring

Size: A = 450 B = Φ 50.8
C = Φ 22

QTY/CTN	N.W/CTN	G.W/CTN	CARTON BOX SIZE
450mm: 10 pcs	13.00	14.00	45.5x45.5x58(cm)
400mm: 10 pcs	10.5	11.5	40.5x45x58(cm)

FOOTRINGS

FT-101

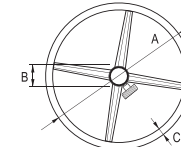

Material: Stainless steel ring + Iron cross

Size: A = 450 B = Φ 50.8
C = Φ 22

FT-02

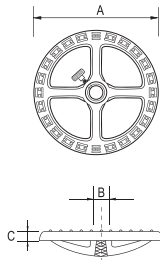

Material: PP

Size: A = 450 B = Φ 50.8
C = Φ 20

QTY/CTN	N.W/CTN	G.W/CTN	CARTON BOX SIZE
10 Pairs	12.00	13.10	52x47x47(cm)

FT-12/1

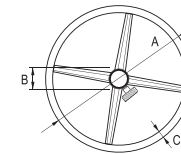

Material: Aluminium cross + Chromed ring

Size: A = 450 B = Φ 50.8
C = Φ 22

FT-04

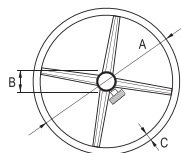

Material: Stainless steel ring + Iron cross

Size: A = 450 B = Φ 55
C = Φ 20

QTY/CTN	N.W/CTN	G.W/CTN	CARTON BOX SIZE
450mm: 10 pcs	9.0	10.0	46.5x46.5x54(cm)
400mm: 10 pcs	10.5	11.5	41.5x41.5x54(cm)

FT-05

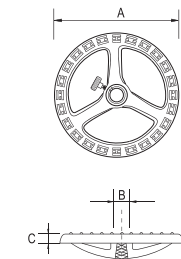

Material: PP

Size: A = 450 B = Φ 50.8
C = Φ 25

NYLON & PU CASTERS

CT-01

Caster Ø50mm, pin Ø11mm, PA

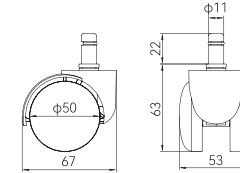

QTY/CTN	N.W/CTN	G.W/CTN	CARTON BOX SIZE
200 pcs	18.7	19.5	60x29x26(cm)

CT50-022PAT

Caster Ø50mm, pin Ø11mm, PA (Raise brake)

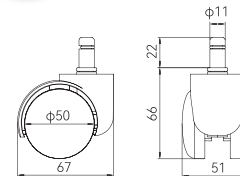

QTY/CTN	N.W/CTN	G.W/CTN	CARTON BOX SIZE
200 pcs	20.2	21	61x30x25.6(cm)

CT50-023BT

Caster Ø50mm, pin Ø11mm, PA+PU (Raise brake)

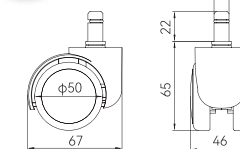

QTY/CTN	N.W/CTN	G.W/CTN	CARTON BOX SIZE
200 pcs	21.9	22.7	61x30x25.6(cm)



Casters Series

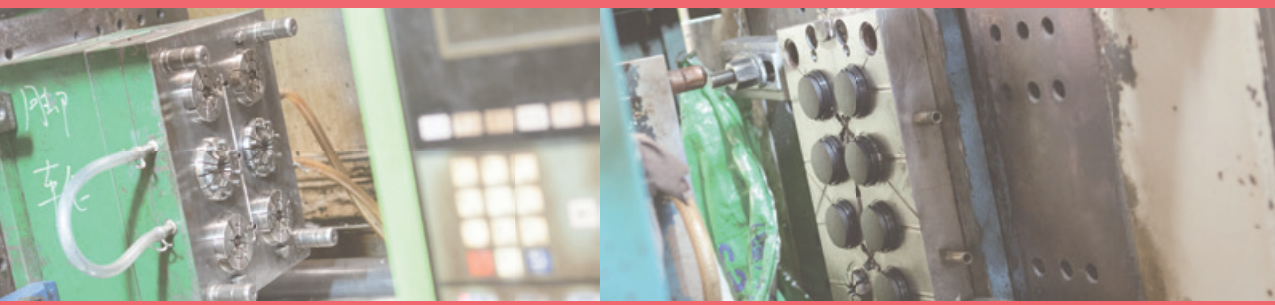

NYLON & PU CASTERS

CT50-024BL

Caster Ø50mm, pin Ø11mm, PA+PU (Seat brake)



QTY/CTN	N.W/CTN	G.W/CTN	CARTON BOX SIZE
200 pcs	21.9	22.7	61x30x25.6(cm)

CT50-032B

Caster Ø50mm, pin Ø11mm, PA/PU



QTY/CTN	N.W/CTN	G.W/CTN	CARTON BOX SIZE
200 pcs	28.2	29	64x30x33.5(cm)

CT50-051G

Caster Ø50mm, pin Ø11mm, PA+PU



QTY/CTN	N.W/CTN	G.W/CTN	CARTON BOX SIZE
200 pcs	20.4	21.2	60x29x26(cm)

NYLON & PU CASTERS

CT50-052GH

Caster Ø50mm, pin Ø11mm, PA+PU



QTY/CTN	N.W/CTN	G.W/CTN	CARTON BOX SIZE
200 pcs	21	21.8	64x29x26(cm)

CT50-053BH

Caster Ø50mm, pin Ø11mm, PA+PU



QTY/CTN	N.W/CTN	G.W/CTN	CARTON BOX SIZE
200 pcs	22.7	23.5	60x29x26(cm)

CT50-061W

Caster Ø50mm, pin Ø11mm, PA+PU



QTY/CTN	N.W/CTN	G.W/CTN	CARTON BOX SIZE
200 pcs	21.7	22.5	60x29x26(cm)

NYLON & PU CASTERS

CT50-062B

Caster Ø50mm, pin Ø11mm, PA+PU

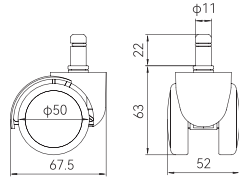

CT50-062G

QTY/CTN	N.W/CTN	G.W/CTN	CARTON BOX SIZE
200 pcs	21.7	22.5	60x29x26(cm)

NYLON & PU CASTERS

CT50-131PA

Caster Ø50mm, pin Ø11mm, PA+PU

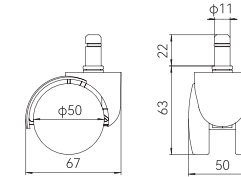

CT50-132PA



CT50-133PA

QTY/CTN	N.W/CTN	G.W/CTN	CARTON BOX SIZE
200 pcs	18.7	19.5	60x29x26(cm)

CT50-071-2

Caster Ø50mm, pin Ø11mm, PA+PU

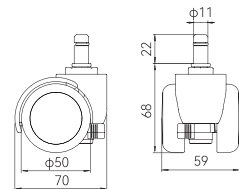

CT50-071-2

QTY/CTN	N.W/CTN	G.W/CTN	CARTON BOX SIZE
200 pcs	29.9	30.7	46x31x35(cm)

CT50-156B

Caster Ø50mm, pin Ø11mm, PA+PU

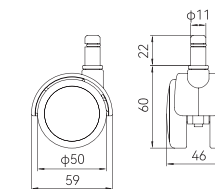

CT50-156W



CT50-156B

QTY/CTN	N.W/CTN	G.W/CTN	CARTON BOX SIZE
200 pcs	20.4	21.2	60x29x26(cm)

CT50-072-1

Caster Ø50mm, pin Ø11mm, PA+PU

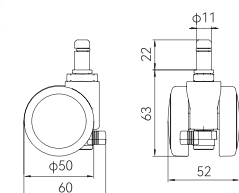

QTY/CTN	N.W/CTN	G.W/CTN	CARTON BOX SIZE
200 pcs	21.7	22.5	60x29x26(cm)

CT50-156BH

Caster Ø50mm, pin Ø11mm, PA+PU

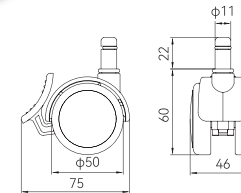

CT50-156GH



CT50-156BH

QTY/CTN	N.W/CTN	G.W/CTN	CARTON BOX SIZE
200 pcs	27.2	28	60x29x26(cm)

NYLON & PU CASTERS

CT50-171-1

Caster Ø50mm, pin Ø11mm, PA+PU

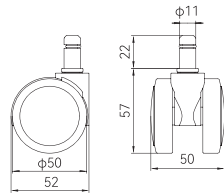

CT50-171PA

QTY/CTN	N.W/CTN	G.W/CTN	CARTON BOX SIZE
250 pcs	24	24.8	60x29x26(cm)

CT50-181W

Caster Ø50mm, pin Ø11mm, PA+PU

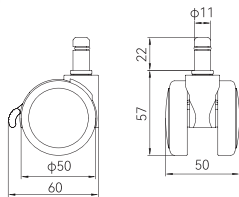

CT50-181-1



CT50-181B

QTY/CTN	N.W/CTN	G.W/CTN	CARTON BOX SIZE
250 pcs	24.9	25.7	60x29x26(cm)

CT50-191B

Caster Ø50mm, pin Ø11mm, PA+P

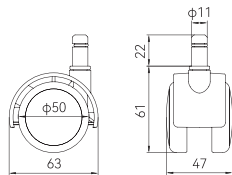

CT50-191H



CT50-191G



CT50-191S



CT50-191W

QTY/CTN	N.W/CTN	G.W/CTN	CARTON BOX SIZE
200 pcs	22.2	23	60x29x26(cm)

NYLON & PU CASTERS

CT50-192GT

Caster Ø50mm, pin Ø11mm, PA+PU

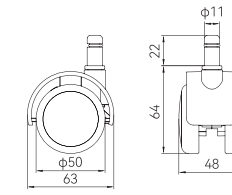

CT50-192BT

QTY/CTN	N.W/CTN	G.W/CTN	CARTON BOX SIZE
200 pcs	22.9	23.7	61x30x25.6(cm)

CT50-201BT

Caster Ø50mm, pin Ø11mm, PA+PU

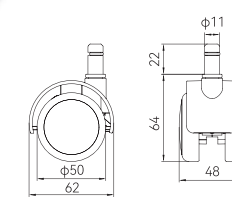

CT50-201ST



CT50-201PAT

QTY/CTN	N.W/CTN	G.W/CTN	CARTON BOX SIZE
250 pcs	21.2	22	61x30x25.6(cm)

CT50-211W

Caster Ø50mm, pin Ø11mm, PA+PU

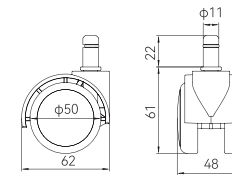

CT50-211G



CT50-211B

QTY/CTN	N.W/CTN	G.W/CTN	CARTON BOX SIZE
200 pcs	21.2	22	60x29x26(cm)

NYLON & PU CASTERS

CT50-501PA

Caster Ø50mm, pin Ø11mm, PA

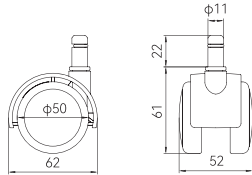

CT50-502PA

QTY/CTN	N.W/CTN	G.W/CTN	CARTON BOX SIZE
200 pcs	20.4	21.2	60x29x26(cm)

NYLON & PU CASTERS

CT50-521PAH

Caster Ø50mm, pin Ø11mm, PA

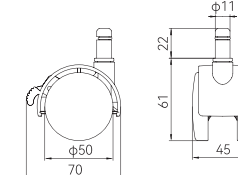

QTY/CTN	N.W/CTN	G.W/CTN	CARTON BOX SIZE
200 pcs	22.2	23	61x30x25.6(cm)

CT50-507PA

Caster Ø50mm, pin Ø11mm, PA

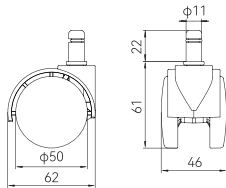

QTY/CTN	N.W/CTN	G.W/CTN	CARTON BOX SIZE
250 pcs	22.2	23	61x30x25.6(cm)

CT50-522PAH

Caster Ø50mm, pin Ø11mm, PA

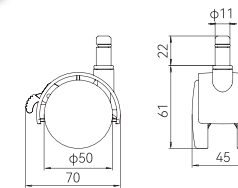

QTY/CTN	N.W/CTN	G.W/CTN	CARTON BOX SIZE
200 pcs	22.2	23	61x30x25.6(cm)

CT50-511PA

Caster Ø50mm, pin Ø11mm, PA

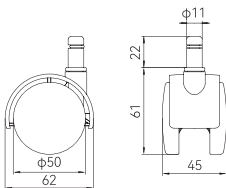

QTY/CTN	N.W/CTN	G.W/CTN	CARTON BOX SIZE
200 pcs	22.2	23	61x30x25.6(cm)

CT55-221-3

Caster Ø55mm, pin Ø11mm, PA

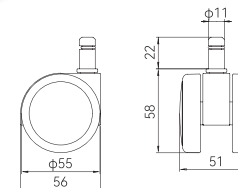

QTY/CTN	N.W/CTN	G.W/CTN	CARTON BOX SIZE
200 pcs	20	20.8	60x29x26(cm)



CT55-221-1

NYLON & PU CASTERS

CT60-291PAH

Caster Ø60mm, pin Ø11mm, PA

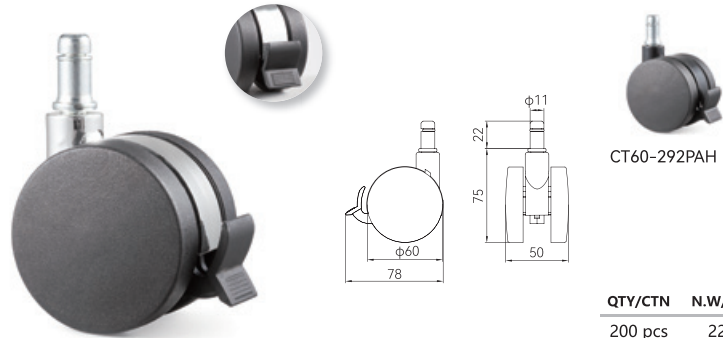

CT60-292PAH

QTY/CTN	N.W/CTN	G.W/CTN	CARTON BOX SIZE
200 pcs	22.2	23	40x29x35(cm)

CT60-294PA

Caster Ø60mm, pin Ø11mm, PA



QTY/CTN	N.W/CTN	G.W/CTN	CARTON BOX SIZE
200 pcs	22.2	23	40x29x35(cm)

CT60-297PA

Caster Ø60mm, pin Ø11mm, PA



QTY/CTN	N.W/CTN	G.W/CTN	CARTON BOX SIZE
200 pcs	22.2	23	40x29x35(cm)

NYLON & PU CASTERS

CT60-431B

Caster Ø60mm, pin Ø11mm, PA+PU



QTY/CTN	N.W/CTN	G.W/CTN	CARTON BOX SIZE
200 pcs	22.2	23	46x29.5x35(cm)

CT60-461-BT

Caster Ø60mm, pin Ø11mm, PA (Brake)



QTY/CTN	N.W/CTN	G.W/CTN	CARTON BOX SIZE
200 pcs	24.5	25.3	60x32.5x29(cm)

CT60-605G

Caster Ø60mm, pin Ø11mm, PA+PU

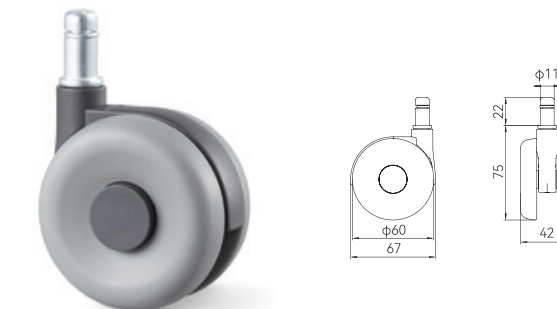

QTY/CTN	N.W/CTN	G.W/CTN	CARTON BOX SIZE
200 pcs	19.2	20	60x29x26(cm)

NYLON & PU CASTERS

CT60-615GH

Caster Ø60mm, pin Ø11mm, PA+PU

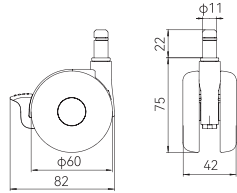

CT60-611SH



CT60-612BH

QTY/CTN	N.W/CTN	G.W/CTN	CARTON BOX SIZE
200 pcs	21.2	20	60x29x26(cm)

NYLON & PU CASTERS

CT60-903B

Caster Ø60mm, pin Ø11mm, PA+PU

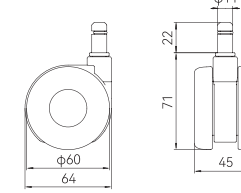

CT60-905B



CT60-902S

QTY/CTN	N.W/CTN	G.W/CTN	CARTON BOX SIZE
100 pcs	27.2	28	38x31.5x19.5(cm)

CT60-635PA

Caster Ø60mm, pin Ø11mm, PA

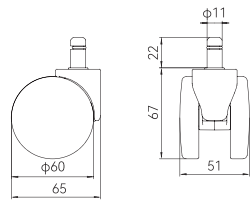

QTY/CTN	N.W/CTN	G.W/CTN	CARTON BOX SIZE
200 pcs	22.2	23	46x29.5x35(cm)

CT65-065GT

Caster Ø65mm, pin Ø11mm, PA+PU (Brake)

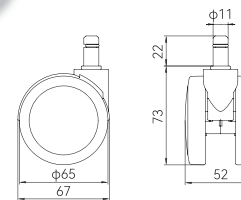

CT65-065BT

QTY/CTN	N.W/CTN	G.W/CTN	CARTON BOX SIZE
250 pcs	22.2	23	46x29.5x35(cm)

CT60-636PA

Caster Ø60mm, pin Ø11mm, PA

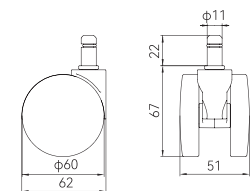

QTY/CTN	N.W/CTN	G.W/CTN	CARTON BOX SIZE
200 pcs	22.2	23	46x29.5x35(cm)

CT65-606B

Caster Ø65mm, pin Ø11mm, PA+PU

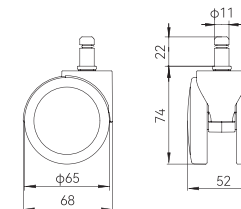

CT65-606W



CT65-605B



CT65-606H

QTY/CTN	N.W/CTN	G.W/CTN	CARTON BOX SIZE
200 pcs	29.2	30	60x32.5x30(cm)

NYLON & PU CASTERS

CT65-608B

Caster Ø65mm, pin Ø11mm, PA+PU

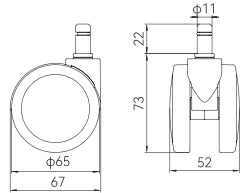

CT65-608R



CT65-609G



CT65-609W

QTY/CTN	N.W/CTN	G.W/CTN	CARTON BOX SIZE
200 pcs	28.2	29	60x32.5x30(cm)

NYLON & PU CASTERS

CT75-758G

Caster Ø75mm, pin Ø11mm, PA

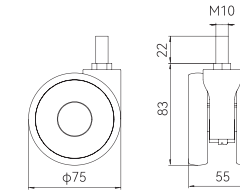

QTY/CTN	N.W/CTN	G.W/CTN	CARTON BOX SIZE
100 pcs	19.2	20	46x29.5x35(cm)

CT65-611G

Caster Ø65mm, pin Ø11mm, PA+PU

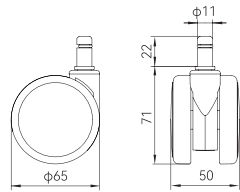

QTY/CTN	N.W/CTN	G.W/CTN	CARTON BOX SIZE
200 pcs	23.2	24	46x29.5x35(cm)

CT75-759GH

Caster Ø75mm, pin Ø11mm, PA

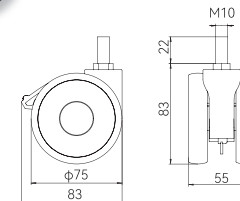

QTY/CTN	N.W/CTN	G.W/CTN	CARTON BOX SIZE
100 pcs	19.2	20	46x29.5x35(cm)

CT65-661B

Caster Ø65mm, pin Ø11mm, PA

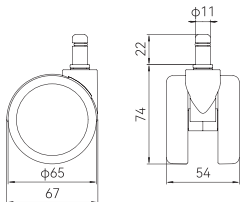

CT65-662B

QTY/CTN	N.W/CTN	G.W/CTN	CARTON BOX SIZE
200 pcs	29	29.8	60x32.5x35(cm)

CT75-762H

Caster Ø75mm, pin Ø11mm, PA

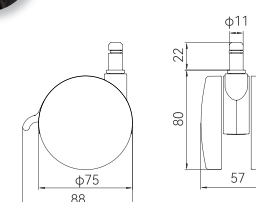

QTY/CTN	N.W/CTN	G.W/CTN	CARTON BOX SIZE
100 pcs	14.2	15	46x29.5x35(cm)

NYLON & PU CASTERS

CT75-765GT

Caster Ø75mm, pin Ø11mm, PA+PU(Brake)



QTY/CTN	N.W/CTN	G.W/CTN	CARTON BOX SIZE
100 pcs	14.2	15	46x29.5x35(cm)

NYLON & PU CASTERS

CT75-767-1

Caster Ø75mm, pin Ø11mm, PA+PU



QTY/CTN	N.W/CTN	G.W/CTN	CARTON BOX SIZE
100 pcs	14.2	15	46x29.5x35(cm)

CT75-766B

Caster Ø75mm, pin Ø11mm, PA+PU

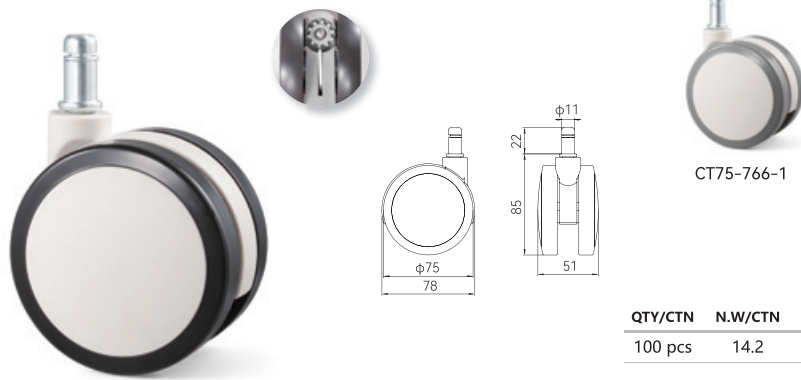

QTY/CTN	N.W/CTN	G.W/CTN	CARTON BOX SIZE
100 pcs	14.2	15	46x29.5x35(cm)

CT75-871-1

Caster Ø63 / Ø75mm, pin Ø11mm, PA



QTY/CTN	N.W/CTN	G.W/CTN	CARTON BOX SIZE
100 pcs	22.3	23.1	46x29.5x35(cm)

CT75-766-2

Caster Ø75mm, pin Ø11mm, PA+PU



QTY/CTN	N.W/CTN	G.W/CTN	CARTON BOX SIZE
100 pcs	14.2	15	46x29.5x35(cm)

NYLON & PU CASTERS

CT30-30PA

Caster Ø30mm, pin Ø11mm, PA

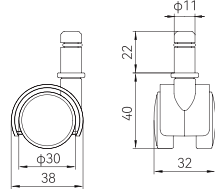

QTY/CTN	N.W/CTN	G.W/CTN	CARTON BOX SIZE
400 pcs	25.7	26.5	61x30x25.6(cm)

CT30-31H

Caster Ø30mm, pin Ø11mm, PA

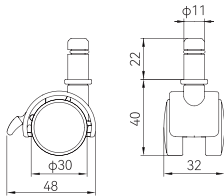

QTY/CTN	N.W/CTN	G.W/CTN	CARTON BOX SIZE
400 pcs	25.7	26.5	61x30x25.6(cm)

CT40-41PA

Caster Ø40mm, pin Ø11mm, PA

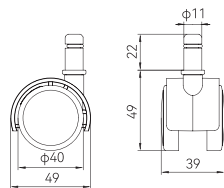

CT40-41-PA-2

QTY/CTN	N.W/CTN	G.W/CTN	CARTON BOX SIZE
400 pcs	26.7	27.5	61x30x25.6(cm)



NYLON & PU CASTERS

CT40-42H

Caster Ø40mm, pin Ø11mm, PA

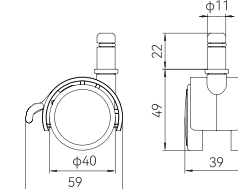

QTY/CTN	N.W/CTN	G.W/CTN	CARTON BOX SIZE
400 pcs	29.2	30	61x30x25.6(cm)

CT40-404G

Caster Ø40mm, pin Ø11mm, PA+PU

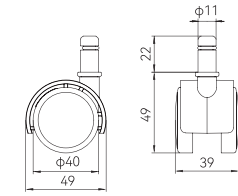

QTY/CTN	N.W/CTN	G.W/CTN	CARTON BOX SIZE
400 pcs	26.7	27.5	61x30x25.6(cm)

CT40-405GH

Caster Ø40mm, pin Ø11mm, PA+PU

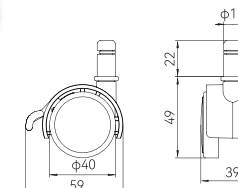

CT40-405BH

QTY/CTN	N.W/CTN	G.W/CTN	CARTON BOX SIZE
400 pcs	29.2	30	61x30x25.6(cm)



NYLON & PU CASTERS

CT50-033-2

Caster Ø53mm, pin Ø11mm, PA

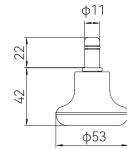

CT50-033-1

QTY/CTN	N.W/CTN	G.W/CTN	CARTON BOX SIZE
200 pcs	10.2	11	43x25x23(cm)

NYLON & PU CASTERS

CT50-033-6

Caster Ø50mm, pin Ø11mm, PA

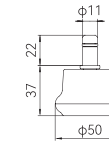

CT50-033-5

QTY/CTN	N.W/CTN	G.W/CTN	CARTON BOX SIZE
200 pcs	10.2	11	43x25x23(cm)

CT50-033-3

Caster Ø50mm, pin Ø11mm, PA

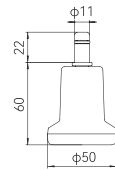

QTY/CTN	N.W/CTN	G.W/CTN	CARTON BOX SIZE
200 pcs	10.2	11	43x25x23(cm)

CT50-033-7

Caster Ø55mm, pin Ø11mm, PA

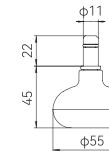

QTY/CTN	N.W/CTN	G.W/CTN	CARTON BOX SIZE
200 pcs	10.2	11	43x25x23(cm)

CT50-033-4

Caster Ø55mm, pin Ø11mm, PA

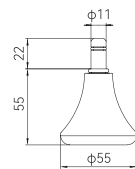

QTY/CTN	N.W/CTN	G.W/CTN	CARTON BOX SIZE
200 pcs	10.2	11	43x25x23(cm)

CT50-033-8

Caster Ø53mm, pin Ø11mm, PA+PU

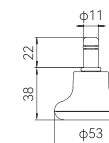

QTY/CTN	N.W/CTN	G.W/CTN	CARTON BOX SIZE
200 pcs	10.2	11	43x25x23(cm)



CT50-033-9



NYLON & PU CASTERS

CT50-033-10

Caster Ø50mm, pin Ø11mm, nylon

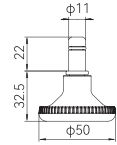

QTY/CTN	N.W/CTN	G.W/CTN	CARTON BOX SIZE
200 pcs	8.2	9	43x25x23(cm)

CT50-033-11

Caster Ø50mm, pin Ø11mm, AL

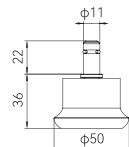

QTY/CTN	N.W/CTN	G.W/CTN	CARTON BOX SIZE
200 pcs	26.2	27	43x25x23(cm)

Pin Optional for all casters



PIN-01



PIN-02



PIN-03



PIN-04



PIN-05

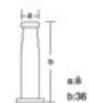

PIN-06



PIN-07



GASLIFTS AND TELESCOPIC COVERS



GC-65B

GC-80B

GC-100B

GC-120B

GC-140B

GC-200B

GC-260B



GC-65C

GC-80C

GC-100C

GC-120C

GC-140C

GC-200C

GC-260C



TC-01

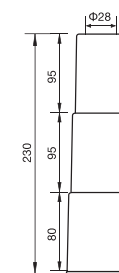

TC-02

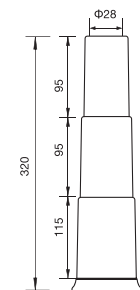



MECHANISMS



MECHANISMS

MC-01A

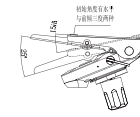
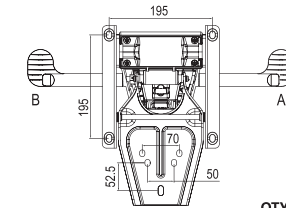

Main Material: Iron

QTY/CTN	N.W/CTN	G.W/CTN	CARTON BOX SIZE
4 pcs	13.60	14.60	54x54x21(cm)

MC-01B

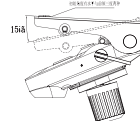
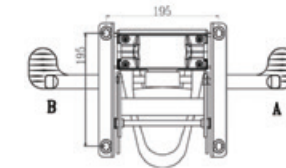

Main Material: Iron

QTY/CTN	N.W/CTN	G.W/CTN	CARTON BOX SIZE
4 pcs	13.60	14.60	54x54x21(cm)

MC-YH012AL

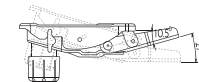
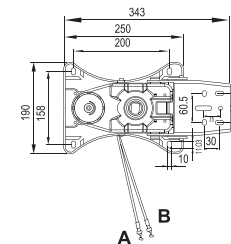

Main Material: Iron

QTY/CTN	N.W/CTN	G.W/CTN	CARTON BOX SIZE
4 pcs	16.40	17.40	67x50x14(cm)



MECHANISMS

MC-18

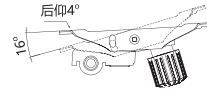
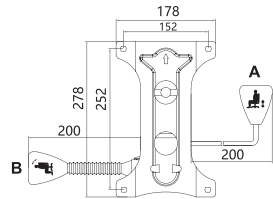

Main Material: Iron

QTY/CTN	N.W/CTN	G.W/CTN	CARTON BOX SIZE
5 pcs	15.00	16.00	53x36x23.5(cm)

MECHANISMS

MC-G011

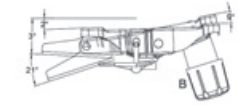
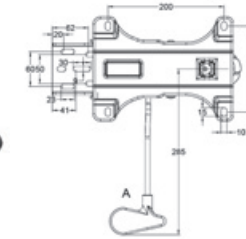

/ Make to accept gas lift;
/ Synchronized Mechanism;
/ Lever A for seat height adjustment;
/ Lever A for seat tilting locking/unlocking
(seat tilting from 2° to 9°/ back tilting from
-3° or 0° to 21°);
/ Lever B for spring tension adjustment.

MC-04

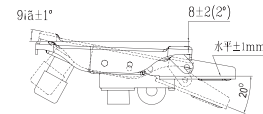
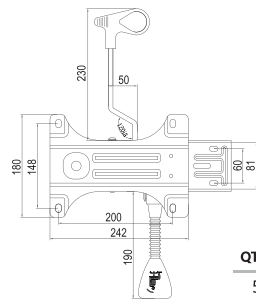

Main Material: Iron

QTY/CTN	N.W/CTN	G.W/CTN	CARTON BOX SIZE
5 pcs	15.00	16.00	53x36x23.5(cm)

MC-G015

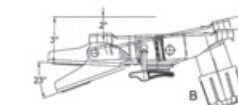
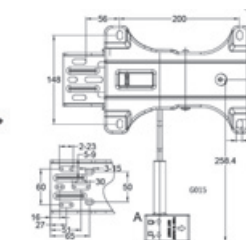

/ Make to accept gas lift;
/ Synchronized Mechanism;
/ Lever A for seat height adjustment;
/ Lever A for seat tilting locking/unlocking in 3 positing;
(seat tilting from 2° to 10°/ back tilting from
0° to 23°);
/ Lever B for spring tension adjustment.

MC-05

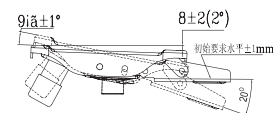
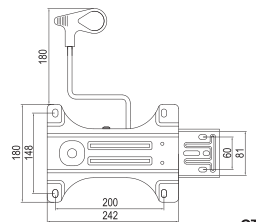

Main Material: Iron

QTY/CTN	N.W/CTN	G.W/CTN	CARTON BOX SIZE
8 pcs	21.60	22.60	59x33x20(cm)

MC-F027

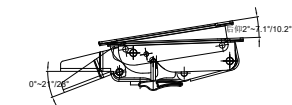
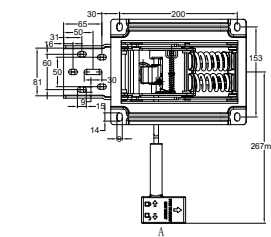

/ Make to accept gas lift;
/ Synchronized Mechanism;
/ Cable A for seat height adjustment;
/ Cable B for tilting locking in 4 positions/
unlocking(Optional 5 positions);
(seat tilting from 2° to 7.1°/ back tilting from 0°to 21°)
(Optional 28°)
/ Cable C for the seat slide function in 7
positions(stroke: 70mm).

MECHANISMS

MC-10

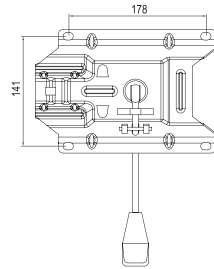

Main Material: Iron

QTY/CTN	N.W/CTN	G.W/CTN	CARTON BOX SIZE
15 pcs	25.50	26.50	49.5x37x26(cm)

MECHANISMS

MC-14A

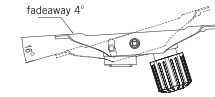
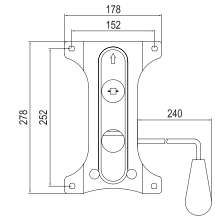

Main Material: Iron

QTY/CTN	N.W/CTN	G.W/CTN	CARTON BOX SIZE
12 pcs	20.40	21.40	49.5x34x20(cm)

MC-11

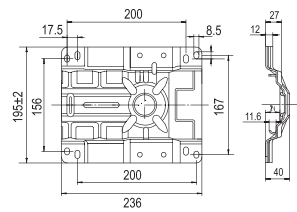

Main Material: Iron

QTY/CTN	N.W/CTN	G.W/CTN	CARTON BOX SIZE
15 pcs	21.00	22.00	49.5x37x26(cm)

MC-14B

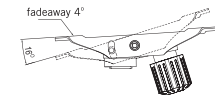
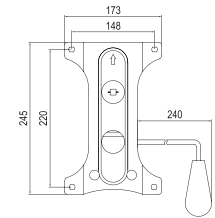

Main Material: Iron

QTY/CTN	N.W/CTN	G.W/CTN	CARTON BOX SIZE
12 pcs	18.00	19.00	47.5x34x20(cm)

MC-13

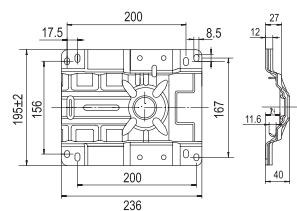

Main Material: Iron

QTY/CTN	N.W/CTN	G.W/CTN	CARTON BOX SIZE
15 pcs	18.45	19.25	49x40.5x20.5(cm)

MC-16

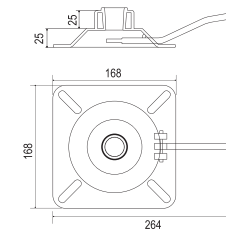

Main Material: Iron

QTY/CTN	N.W/CTN	G.W/CTN	CARTON BOX SIZE
25 pcs	18.00	19.00	49x34x20(cm)

MECHANISMS

MC-06

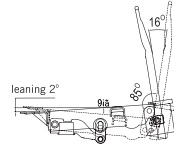
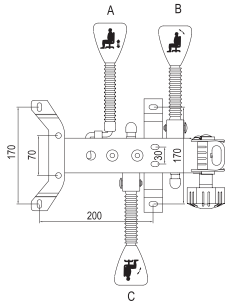

Main Material: Iron

	QTY/CTN	N.W/CTN	G.W/CTN	CARTON BOX SIZE
Mechanism:	10 pcs	17.40	18.40	46x43x36(cm)
T-bone:	50 pcs	21.90	22.33	43x40x15(cm)
Bellow:	100 pcs	6.80	6.90	42x36x72(cm)

MC-07

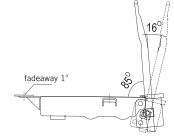
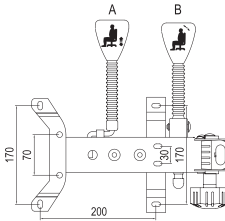

Main Material: Iron

	QTY/CTN	N.W/CTN	G.W/CTN	CARTON BOX SIZE
Mechanism:	10 pcs	21.80	22.80	43x36x36(cm)
T-bone:	50 pcs	21.90	22.33	43x40x15(cm)
Bellow:	100 pcs	6.80	6.90	42x36x72(cm)

MC-HF009A

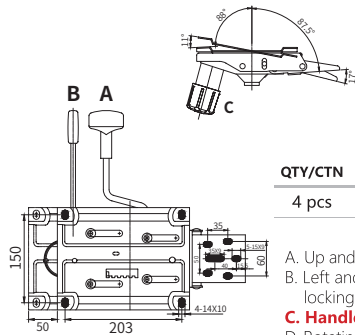

Main Material: Iron

	QTY/CTN	N.W/CTN	G.W/CTN	CARTON BOX SIZE
	4 pcs	17.2	18	49.5x42x16(cm)

- A. Up and down poking handle A for seat height adjustment.
- B. Left and right poking handle A can be locked in 3 locking angles.
- C. Handle B for seat slider and 6 locking positions.
- D. Rotating spring box C for the tension adjustment of the spring.



MECHANISMS

MC-HF015A

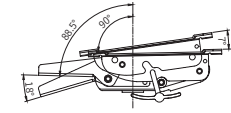
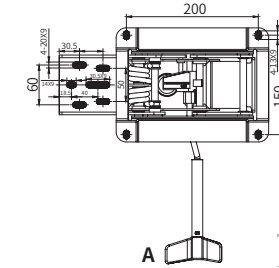

Main Material: Iron

	QTY/CTN	N.W/CTN	G.W/CTN	CARTON BOX SIZE
	4 pcs	11.2	12.2	35x33x18.5(cm)

MC-HF039

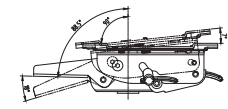
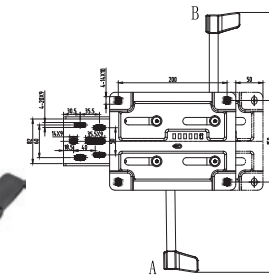

Main Material: Iron

	QTY/CTN	N.W/CTN	G.W/CTN	CARTON BOX SIZE
	4 pcs	11.2	12.2	35x33x18.5(cm)

MC-T005

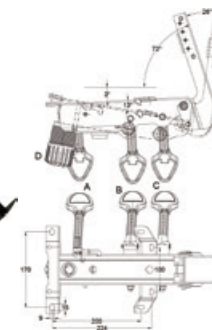

- / Make to accept gas lift;
- / Synchronized Mechanism;
- / Lever A for seat height adjustment;
- / Lever B for seat tilting locking at any degree/unlocking (seat tilting from -3° to 12°);
- / Lever C for back tilting locking at any degree/unlocking (back tilting from -18° to 26°);
- / Lever D for spring tension adjustment.



MECHANISMS

MC-T005C



/ Make to accept gas lift;
 / Synchronized Mechanism;
 / Lever A for seat height adjustment;
 / Lever B for tilting locking at any degree/unlocking
 (seat tilting from 0° to 12°/ back tilting from -5°
 to 23°);
 / Lever C for spring tension adjustment.

B back Bar (for T005 and T005C)

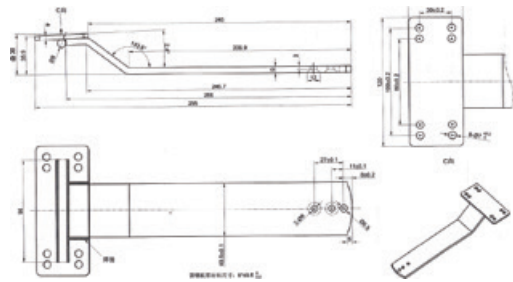

C back Bar (for T005 and T005C)

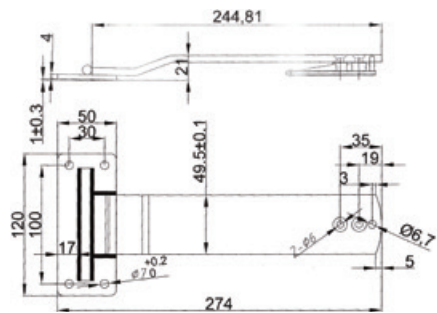

BRACKETS . SCREWS . T-NUTS

BK-09

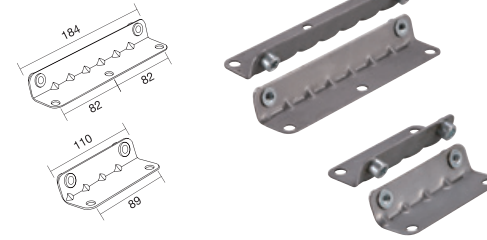

BK-10

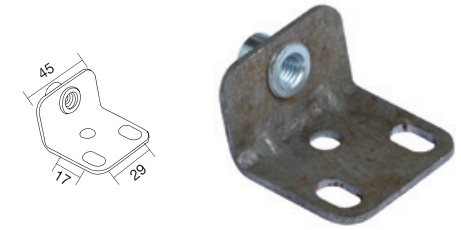

SR-01

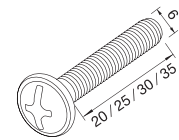

(M6x20, 25,30,35)

SR-02

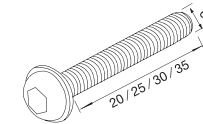

(M6x20, 25,30,35)

SR-03

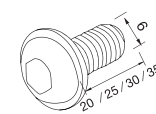

(M6x20, 25,30,35)

SR-04

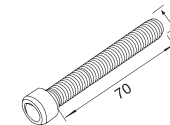

(M8x50, M8x70)

LW-01

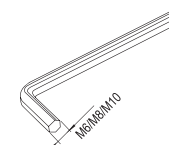

(M6, M8, M10)

T-NUTS

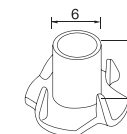

(M6x10, M6x12)



CHAIR KITS



CHAIR KITS

KT-GS021H



Chair Kits components specification:

Back frame:	MB-GS02 Mesh back frame, Nylon with GP
Headrest :	with Height adjustable function
Seat Cover:	ST-GS02 ,PP material
Seat Plywood:	ST-GS02P , strong plywood T=12.0mm
Amrest:	AD-18A, adjustable arm with PU armpad
Mechanism:	MC-01B, sincro mechanism
Gaslift:	GC-60B, 60mm black color
Nylon base:	PA-N320, D=320mm, nylon with GF
Nylon Caster:	CT60-272, wheel diameter 60mm



KT-GS02M



Chair Kits components specification:

Back frame:	MB-GS02 Mesh back frame, Nylon with GP
Seat Cover:	ST-GS02 ,PP material
Seat Plywood:	ST-GS02P , strong plywood T=12.0mm
Amrest:	AD-18A, adjustable arm with PU armpad
Mechanism:	MC-01B, sincro mechanism
Gaslift:	GC-60B, 60mm black color
Nylon base:	PA-N320, D=320mm, nylon with GF
Nylon Caster:	CT60-272, wheel diameter 60mm



CHAIR KITS

KT-GS023H



Chair Kits components specification:

Back frame:	MB-GS02 Mesh back frame, Nylon with GP
Headrest :	with Height adjustable function
Seat Cover:	ST-GS02 ,PP material
Seat Plywood:	ST-GS02P , strong plywood T=12.0mm
Amrest:	AD-18A, adjustable arm with PU armpad
Mechanism:	MC-14B , Butterfly Mechanism. Thickness 2.5mm
Gaslift:	GC-80BK, 80mm black color
Nylon base:	PA-N320, D=320mm, nylon with GF
Nylon Caster:	CT60-272, wheel diameter 60mm

KT-GS023M



Chair Kits components specification:

Back frame:	MB-GS02 Mesh back frame, Nylon with GP
Seat Cover:	ST-GS02 ,PP material
Seat Plywood:	ST-GS02P , strong plywood T=12.0mm
Amrest:	AD-18A, adjustable arm with PU armpad
Mechanism:	MC-14B , Butterfly Mechanism. Thickness 2.5mm
Gaslift:	GC-80BK, 80mm black color
Nylon base:	PA-N320, D=320mm, nylon with GF
Nylon Caster:	CT60-272, wheel diameter 60mm



CHAIR KITS

KT-FN02H



Chair Kits components specification:

Back frame:	MB-FN02 Mesh back frame, Nylon with GP
Headrest :	with Height adjustable function
Seat Cover:	ST-2001 ,PP material
Seat Plywood:	ST-2001P , strong plywood T=12.0mm
Amrest:	AD-18A, adjustable arm with PU armpad
Mechanism:	MC-05, Tilting and locking mechanism
Gaslift:	GC-100BK,100mm black color
Nylon base:	PA-N320, D=320mm, nylon with GF
Nylon Caster:	CT60-272, wheel diameter 60mm

KT-FN02M



Chair Kits components specification:

Back frame:	MB-FN02 Mesh back frame, Nylon with GP
Seat Cover:	ST-2001 ,PP material
Seat Plywood:	ST-2001P , strong plywood T=12.0mm
Amrest:	AD-18A, adjustable arm with PU armpad
Mechanism:	MC-05, Tilting and locking mechanism
Gaslift:	GC-100BK,100mm black color
Nylon base:	PA-N320, D=320mm, nylon with GF
Nylon Caster:	CT60-272, wheel diameter 60mm



CHAIR KITS

KT-GR022H



Chair Kits components specification:

Back frame:	MB-GR02 Mesh back frame, Nylon with GP
Headrest :	with Height adjustable function
Seat Cover:	ST-2001 ,PP material
Seat Plywood:	ST-2001P , strong plywood T=12.0mm
Amrest:	AD-18A, adjustable arm with PU armpad
Mechanism:	MC-G011, Tilting and 3 step locking mechanism
Gaslift:	GC-100BK,100mm black color
Nylon base:	PA-N320, D=320mm, nylon with GF
Nylon Caster:	CT60-272, wheel diameter 60mm

KT-GR022M



Chair Kits components specification:

Back frame:	MB-GR02 Mesh back frame, Nylon with GP
Seat Cover:	ST-2001 ,PP material
Seat Plywood:	ST-2001P , strong plywood T=12.0mm
Amrest:	AD-18A, adjustable arm with PU armpad
Mechanism:	MC-G011, Tilting and 3 step locking mechanism
Gaslift:	GC-100BK,100mm black color
Nylon base:	PA-N320, D=320mm, nylon with GF
Nylon Caster:	CT60-272, wheel diameter 60mm



CHAIR KITS

KT-01M



Chair Kits components specification:

Back Cover:	BC-01M outer and inner, PP material
Seat Cover:	ST-01 ,PP material
Seat Plywood:	ST-01P , strong plywood T=10.0mm
Amrest:	AR-06, PP armrest
Mechanism:	MC-10, plate thickness 2.5mm
Gaslift:	GC-120BK, 120mm black color
Telescopic cover:	TC-02, PP material
Nylon base:	PA-A300, D=300mm, nylon with GF
Nylon Caster:	CT-01, D=50mm

KT-01H



Chair Kits components specification:

Back Cover:	BC-01H outer and inner, PP material
Seat Cover:	ST-01 ,PP material
Seat Plywood:	ST-01P , strong plywood T=10.0mm
Amrest:	AR-06, PP armrest
Mechanism:	MC-10, plate thickness 2.5mm
Gaslift:	GC-120BK, 120mm black color
Telescopic cover:	TC-02, PP material
Nylon base:	PA-A300, D=300mm, nylon with GF
Nylon Caster:	CT-01, D=50mm



CHAIR KITS

KT-KB023H



Chair Kits components specification:

- Back inner:** BC-KB02 plastic back inner ,PP material
- Back outer:** BC-KB02 plastic back inner ,PP material
- Back below:** BC-KB02 back plastic below,PP material
- Headrest :** with Height adjustable function
- Seat inner:** ST-KB02 plastic seat inner cover, PP material
- Seat outer:** ST-KB02 plastic seat outer cover, Nylon material
- Amrest:** AD-18B, adjustable armrest with PU armpad.
- Mechanism:** MC-04 two level mechanism
- Gaslift:** GC-100BK, 100MM black gaslift.
- Nylon base:** PA-N340, D=340mm, nylon with GF
- Nylon Caster:** CT60-272, wheel diameter 60mm

KT-KB023M



Chair Kits components specification:

- Back inner:** BC-KB02 plastic back inner ,PP material
- Back outer:** BC-KB02 plastic back inner ,PP material
- Back below:** BC-KB02 back plastic below,PP material
- Seat inner:** ST-KB02 plastic seat inner cover, PP material
- Seat outer:** ST-KB02 plastic seat outer cover, Nylon material
- Amrest:** AD-18B, adjustable armrest with PU armpad.
- Mechanism:** MC-04 two level mechanism
- Gaslift:** GC-100BK, 100MM black gaslift.
- Nylon base:** PA-N340, D=340mm, nylon with GF
- Nylon Caster:** CT60-272, wheel diameter 60mm



CHAIR KITS

KT-FS02M



Chair Kits components specification:

- Back frame:** MB-FS02 Mesh back frame, Nylon with GP
- Seat Cover:** ST-05 ,PP material
- Seat Plywood:** ST-05P , strong plywood T=12.0mm
- Amrest:** AR-023, PP armrest
- Mechanism:** MC-05, T= 3.0mm
Optional mechanism : MC-14, T=2.5mm
- Back Bracket:** Black powder coating, T=6.0mm
- Gaslift:** GC100BK, 100mm black color
- Nylon base:** PA-N320, D=320mm, nylon with GF
- Nylon Caster:** CT60-272

KT-GA023H



Chair Kits components specification:

- Back frame:** MB-GA02 Mesh back frame, Nylon with GP
- Headrest :** with Height adjustable function
- Seat Cover:** ST-GA02 ,PP material
- Seat Plywood:** ST-GA02P , strong plywood T=12.0mm
- Amrest:** AD-31, adjustable arm with PU armpad
- Mechanism:** MC-G011 one level mechanism with tilt and lock at 3 positions function
- Gaslift:** GC-100BK, 100mm black gaslift
- Nylon base:** PA-N320, D=320mm, nylon with GF
- Nylon Caster:** CT60-272, wheel diameter 60mm



CHAIR KITS

KT-2003



Chair Kits components specification:

Back frame:	MB-01 Mesh back frame, Nylon with GP
Seat Cover:	ST-2001 ,PP material
Seat Plywood:	ST-2001P , strong plywood T=12.0mm
Amrest:	AD-15+AP-PU01 PU armpad
Mechanism:	MC-04, sincro mechanism
Gaslift:	GC-80BK, 80mm black color
Nylon base:	PA-N340, D=340mm, nylon with GF
Nylon Caster:	CT60-272

KT-1506M



Chair Kits components specification:

Back frame:	MB-1506 Mesh back frame, Nylon with GP
Seat Cover:	ST-GS02 ,PP material
Seat Plywood:	ST-GS02P, strong plywood T=12.0mm
Amrest:	AD-06, adjustable arm with PU armpad
Mechanism:	MC-05, T= 3.5mm
Back Bracket:	Black powder coating, T=6.0mm
Gaslift:	GC80BK, 80mm black color
Nylon base:	PA-N320, D=320mm, nylon with GF
Nylon Caster:	CT50-231, wheel diameter 50mm



CHAIR KITS

KT-13H



Chair Kits components specification:

Plywood shell	Plywood shell has two sizes: WD-01H, Size = 1180x52x16mm (or 12mm)
Amrest:	AR-15 PP armrest
Mechanism:	MC-14, T= 2.5mm
Back Bracket:	BK-09 (2 pcs) and BK10 (2 pcs) brackets
Gaslift:	GC-100BK, 100mm black color
Nylon base:	PA-A320, D=320mm, nylon with GF
Nylon Caster:	CT01, wheel diameter 50mm

KT-13M



Chair Kits components specification:

Plywood shell	Plywood shell has two sizes: WD-01M, Size = 1080x52x16mm (or 12mm)
Amrest:	AR-15 PP armrest
Mechanism:	MC-14, T= 2.5mm
Back Bracket:	BK-09 (2 pcs) and BK10 (2 pcs) brackets
Gaslift:	GC-100BK, 100mm black color
Nylon base:	PA-A320, D=320mm, nylon with GF
Nylon Caster:	CT01, wheel diameter 50mm



CHAIR KITS

ISO chair



The ISO components are next to the right page

KT-11



CHAIR KITS

ISO-01

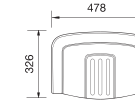

Material: PP

QTY/CTN	N.W/CTN	G.W/CTN	CARTON BOX SIZE
50 pcs	12.50	13.75	70x48x34(cm)

ISO-01P

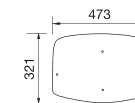

Material: Plywood

QTY/CTN	N.W/CTN	G.W/CTN	CBM
10 pcs	8.80	8.90	0.018

ISO-02

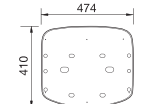

Material: PP

QTY/CTN	N.W/CTN	G.W/CTN	CARTON BOX SIZE
50 pcs	11.99	12.95	49x35x42(cm)

ISO-02P

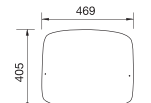

Material: Plywood

QTY/CTN	N.W/CTN	G.W/CTN	CBM
10 pcs	9.50	9.60	0.021

ISO writing table

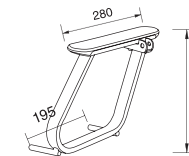

Material: PP+Metal

	QTY/CTN	N.W/CTN	G.W/CTN	CARTON BOX SIZE
armrest:	10 pcs	15.00	16.00	45x38x27(cm)
metal board:	20 pcs			53x32x20.5(cm)
plastic writing board	40 pcs			49x36.5x32(cm)

ISO Arm

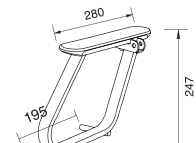

Material: PP+Metal

QTY/CTN	N.W/CTN	G.W/CTN	CARTON BOX SIZE
10 pcs	15.00	15.80	45x38x27(cm)

ISO FRAME (Oval shape)

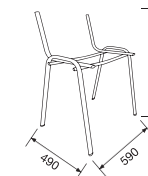

Material: Iron

QTY/CTN	N.W/CTN	G.W/CTN	CBM
1 pcs	3.30	3.33	0.014

ISO FRAME (Round shape)

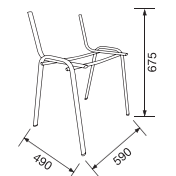

Material: Iron

QTY/CTN	N.W/CTN	G.W/CTN	CBM
1 pcs	3.60	3.70	0.015





PU CHAIR KITS



PU CHAIR KITS

Optional components for PU chair

1. Back and seat: You may choose from the next pages.

2. Mechanism:



MC-07



MC-11



MC-13

3. Bracket:



BK-12

4. Arms:



AD-03



AD-07



AD-11A

5. Gaslifts:



GC-120BK



GC-260BK



GC-120CR



GC-260CR

6. Footring:



FT-01



FT-101



FT-04

7. Bases:



IRB-02-300



IRB-04-300



PA-B300

8. Casters:



CT-01



CT50-231



CT60-272

9. Other:



TC-02



BH-01
Back holder sets



BH-02
Back holder sets



PU CHAIR KITS

PU-BS01



Main Material: PU

	QTY/CTN	N.W/CTN	G.W/CTN	CARTON BOX SIZE
Back:	5 pcs	6.375	7.375	43x26x32(cm)
Seat:	5 pcs	10.70	11.70	48x45x22(cm)

PU CHAIR KITS

PU-BS03



Main Material: PU

	QTY/CTN	N.W/CTN	G.W/CTN	CARTON BOX SIZE
Back:	5 pcs	6.50	7.50	42x25x31.5(cm)
Seat:	5 pcs	12.65	13.65	46x46x24.5(cm)

PU-BS01G



Main Material: PU

	QTY/CTN	N.W/CTN	G.W/CTN	CARTON BOX SIZE
Back:	5 pcs	5.50	6.50	43x22x32(cm)
Seat:	5 pcs	10.60	11.60	48x45x22(cm)

PU-BS02L



Main Material: PU

	QTY/CTN	N.W/CTN	G.W/CTN	CARTON BOX SIZE
Back:	5 pcs	8.35	9.35	41x23x37(cm)
Seat:	5 pcs	11.15	12.15	45x44x24(cm)

PU-BS04



Main Material: PU

	QTY/CTN	N.W/CTN	G.W/CTN	CARTON BOX SIZE
Back:	5 pcs	6.50	7.50	42x25x31.5(cm)
Seat:	5 pcs	12.65	13.65	46x46x24.5(cm)

PU-BS02S



Main Material: PU+Plywood

	QTY/CTN	N.W/CTN	G.W/CTN	CARTON BOX SIZE
Back:	5 pcs	5.85	6.85	38x23x27(cm)
Seat:	5 pcs	11.15	12.15	45x44x24(cm)

PU CHAIR KITS

PU-BS06



Main Material: PU

	QTY/CTN	N.W/CTN	G.W/CTN	CARTON BOX SIZE
Back:	5 pcs	5.75	6.75	39x24x38(cm)
Seat:	5 pcs	11.75	12.75	46x43x26(cm)

PU CHAIR KITS

PU-B029



Main Material: PU

PU-BS-07



Main Material: PU

	QTY/CTN	N.W/CTN	G.W/CTN	CARTON BOX SIZE
Back:	5 pcs	4.35	5.35	38x23x27(cm)
Seat:	5 pcs	9.00	10.00	42.5x42.5x19.5(cm)

PU-B036



Main Material: PU

PU-B040



Main Material: PU

PU-B037



Main Material: PU



PU CHAIR KITS

PU-ST041



Main Material: PU

PU-ST039



Main Material: PU

PU-ST002-1



Main Material: PU



PU CHAIR KITS

PU-ST011-1B



Main Material: PU

PU-ST02



Main Material: PU

QTY/CTN	N.W/CTN	G.W/CTN	CARTON BOX SIZE
10 pcs	10.96	11.96	32.5x32.5x50.5(cm)

PU-ST05



Main Material: PU

QTY/CTN	N.W/CTN	G.W/CTN	CARTON BOX SIZE
5 pcs	16.55	17.55	54x42.8x38(cm)



PU CHAIR KITS

PU-ST06



Main Material: PU

QTY/CTN	N.W/CTN	G.W/CTN	CARTON BOX SIZE
10 pcs	11.26	12.26	35x35x35(cm)

PU CHAIR KITS

PU-ST03



Main Material: PU

QTY/CTN	N.W/CTN	G.W/CTN	CARTON BOX SIZE
10 pcs	14.10	15.10	47.5x37.5x37(cm)

PU-ST07



Main Material: PU

QTY/CTN	N.W/CTN	G.W/CTN	CARTON BOX SIZE
10 pcs	12.60	13.60	35.5x35.5x55(cm)

PU-ST04



Main Material: PU

QTY/CTN	N.W/CTN	G.W/CTN	CARTON BOX SIZE
10 pcs	15.76	16.76	47.5x37.5x37(cm)

PU-ST01



Main Material: PU

QTY/CTN	N.W/CTN	G.W/CTN	CARTON BOX SIZE
10 pcs	12.50	13.50	43x38x36.5(cm)

PU-ST09



Main Material: PU

QTY/CTN	N.W/CTN	G.W/CTN	CARTON BOX SIZE
4 pcs	16.08	17.08	46x43x31(cm)



